

670G LC/870G LC

67–87 metric ton



JOHN DEERE



Expect big things.

When the task demands a serious excavator to get it done, get a John Deere G-Series. With more hydraulic flow than their highly productive predecessors, our 670G LC and 870G LC deliver faster work cycles to move more material on a gallon of fuel. Their rugged Interim Tier 4/EU Stage IIIB diesels enable you to work, wherever there's work, even in nonattainment areas. Numerous customer-inspired refinements include a more comfortable and spacious cab. And an enhanced LCD monitor with simplified navigation that lets an operator easily dial-in a wealth of machine information and functionality. If you're looking to amass more productivity, our G-Series Excavators are a great place to start.

670G LC

Net rated power	345 kW (463 hp)
Operating weight	71 688 kg (158,045 lb.)
Lifting capacity	15 300 kg (32,900 lb.)
Maximum digging depth	9.15 m (30 ft. 0 in.)
Arm digging force	224–231 kN (50,357–51,931 lb.)
Bucket digging force	290–324 kN (65,195–72,838 lb.)

870G LC

397 kW (532 hp)
87 659 kg (193,255 lb.)
20 260 kg (43,800 lb.)
9.57 m (31 ft. 5 in.)
273–280 kN (61,373–62,946 lb.)
359–399 kN (80,706–89,699 lb.)



The IT4/Stage IIIB technology utilized in our diesel engines is simple, fuel efficient, fully integrated, and fully supported.

Hydraulically driven, highly efficient fan runs only as needed, reducing noise, fuel consumption, and operating costs. Standard operator-selectable reversing option automatically back-blows cooler cores to keep them clean.

With a larger entryway, more legroom, and standard air-suspension heated seat, the G-Series' refined cab delivers even more convenience and comfort.

Extended engine and hydraulic oil-service intervals increase uptime and reduce daily operating costs.



670G LC and 870G LC are standard equipped with JDLink™ Ultimate, giving you 24/7 online access to your excavator. Track machine health, utilization, and fuel consumption — valuable information that helps you better understand costs and jobsite performance. Plus, you can help protect your equipment from unauthorized movement by setting up geofence and curfew alerts in your JDLink account.

Powerwise III perfectly balances engine performance and hydraulic flow for predictable operation. Three productivity modes allow you to choose the digging style that fits the job. **High-productivity** delivers more power and faster hydraulic response to move more material. **Power** delivers a balance of power and speed for normal operation. **Economy** limits top speed and helps save fuel.

Choose from a variety of track widths, arm lengths, buckets, and other options.

Smart choice.

Make no mistake, our G-Series Excavators deliver plenty of productive punch. But the 670G LC and 870G LC aren't all brawn and no brains. Smart features like our Powerwise™ III engine/hydraulic management system with multiple productivity modes enable you to put that extra ability to use with the same kind of smooth precision that operators have come to expect from our excavators. What's more, advantages such as our JDLink Ultimate machine monitoring system and Service ADVISOR™ diagnostics help keep you informed about machine utilization and maintenance. Who says you have to choose between working harder or smarter?



1. For work that requires extra finesse, short-throw low-effort controls, unmatched metering, and smooth multifunction operation give you the precision you need.

2. Their exceptional swing torque, lift capacity, and arm and bucket digging force provide generous muscle for mass excavating or hot truck loading.

3. When conditions call for a little extra, simply press the power-boost button on the right-hand control and muscle through.



Here's a new twist on operating ease.

Now it's easier than ever for your operators to "dial things up." The G-Series' refined monitor employs a turn-and-tap rotary control that provides quick access to an abundance of performance and convenience features and functions. Operators will also appreciate the standard air-suspension high-back heated seat and increased legroom in the spacious, well-appointed cab. As always, unsurpassed all-round visibility, low-effort joysticks, a highly efficient HVAC system, and numerous other amenities provide all your operators need to tap into their abilities. And push productivity to the max.

With large self-cleaning steps, convenient handholds, and wide entryways, getting to "the office" has never been easier.

Spacious cab is comfortable and noticeably quiet. Silicone-filled mounts effectively isolate operators from noise and vibration.

We've got your back. Standard equipment includes a multi-position air-suspension heated seat. With 267 mm (10½ in.) of travel, sliding together or independent of the joystick console, there's plenty of legroom so it won't cramp an operator's style.

Ergonomically correct short-throw pilot levers provide smooth, predictable fingertip control.

No shortage of storage in here. There's a place for a cooler, cup holders, and even a hot/cold box that keeps food or beverages at just the right temperature.

Lights on the cab and both sides of the boom illuminate the way for work that begins or extends beyond daylight.

1. Multi-language LCD monitor and rotary dial provide intuitive access to a wealth of information and functions. Just turn and tap to select work mode, access operating info, check maintenance intervals, source diagnostic codes, adjust cab temperature, and tune the radio. Plus much more.
2. Wide expanse of front and side glass, narrow front cab posts, large overhead glass, and numerous mirrors provide virtually unobstructed all-around visibility. A rear-mount camera displays the activity behind you on the monitor in front of you.
3. Automatic, high-velocity bi-level climate-control system with automotive-style adjustable louvers helps keep the glass clear and the cab comfortable.



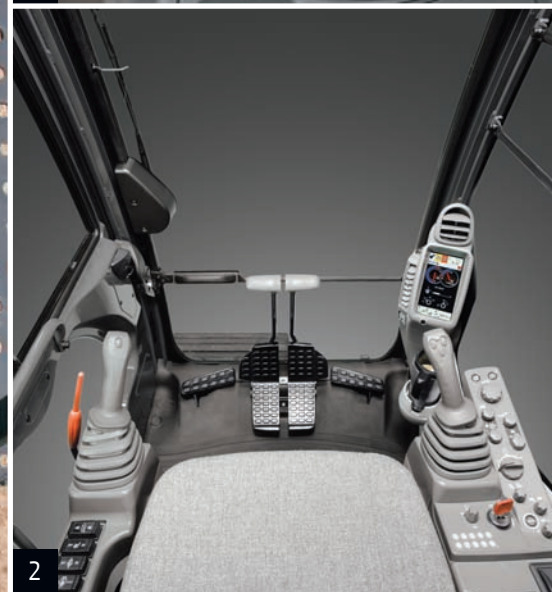

Nothing runs like a Deere, because nothing is built like one.

Chances are, you've got plenty of people, equipment, and other resources relying on your excavators. And you can depend on our G-Series to deliver. Both 670G LC and 870G LC employ many of the same job-proven digging structures and hydraulic, electrical, and undercarriage components as their highly regarded D-Series predecessors. You'll also continue to profit from durability-enhancing "extras" such as welded boom bulkheads, reinforced D-channel side frames, heavy-duty cooling systems, and extended service intervals. When you know how they're built, you'll run a Deere.

Our IT4/Stage IIIB technology is simple, fuel efficient, fully integrated, and fully supported. It employs field-proven cooled exhaust gas recirculation (EGR) for reducing NO_x, and a diesel particulate filter and a diesel oxidation catalyst to reduce particulate matter. Periodic active and passive regeneration automatically cleans the filter without impacting machine productivity.

A John Deere exclusive, three welded bulkheads within the boom resist torsional stress for unsurpassed durability. In fact, boom, arm, and mainframe are so tough, they're warranted for three years or 10,000 hours.

1. Thick-plate single-sheet mainframe, box-section track frames, and industry-exclusive double-seal swing bearings deliver rock-solid durability.

2. Rigid, reinforced D-channel side frames provide maximum cab and component protection.

3. With strutted links and large idlers and rollers, the sealed and lubricated heavy-duty undercarriage delivers long and reliable performance.

4. Highly efficient, heavy-duty cooling system keeps things cool, even in tough environments or high altitudes.

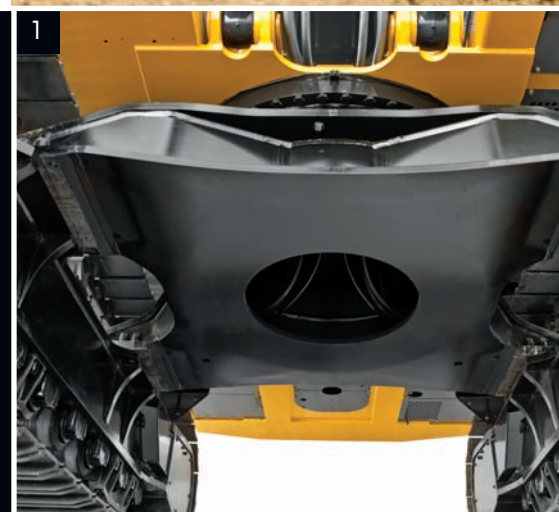

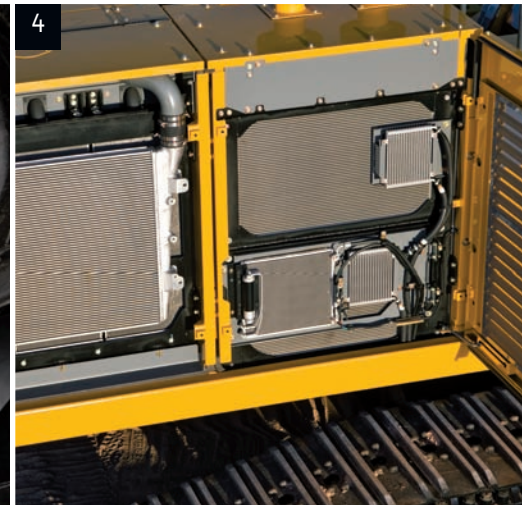

You'll become a big fan of the G-Series.

Swing open the service panels and engine covers, and you'll discover many of the numerous ways we minimize maintenance, increase uptime, and reduce daily operating costs. Take the G-Series' heavy-duty cooling systems, for example. Their hydraulically driven fans run only as fast or often as needed, reducing fuel consumption and wear-causing debris flow through the cooler cores. As always, grouped service points make quick work of the daily routine. Plus, easy-to-check sight gauges and fluid reservoirs, quick-change remote-mounted filters, and advanced self-diagnostics all help ensure that maintenance is no big deal.

Wide, slip-resistant steps and "Deere-walk," sturdy handrails, and large easy-to-open service doors provide convenient access to grouped service points and major components.

Auto-idle automatically reduces engine speed when hydraulics aren't in use. Auto shutdown further preserves precious fuel.

Diesel particulate filter is easily removed through the top of the engine compartment. Minimum service interval is 4,500 hours, and can be done by your John Deere dealer.

Advanced self-diagnostics help you make timely decisions about machine upkeep.

Large fuel tanks and 500- and 4,000-hour engine and hydraulic oil-service intervals decrease downtime for routine maintenance.

Centralized lube banks place difficult-to-lube zerks within easy reach. Convenient color-coded chart helps ensure that nothing gets overlooked.



Engine Oil Filter	
Previous Maintenance	
2011/07/04	0.0 h
Remains	375.8 h
Maintenance Interval	500.0 h



1. Vertical spin-on fuel filters and hydraulic and engine oil filters simplify service and help minimize messes. Filters and checkpoints are conveniently grouped.
2. Fresh-air cab filter can be quickly serviced from outside the cab. Where it's more likely to get done.
3. Easy-to-navigate LCD monitor issues scheduled maintenance alerts. Should a problem arise, it provides diagnostic info and offers possible solutions to decrease downtime.
4. Their unique Turn-Kam retainer enables TK-Series bucket teeth to be installed or removed with a simple half-turn of a wrench. The hammerless system is standard on John Deere buckets.
5. Coolers are well-protected behind heavy-duty hinged doors, yet readily accessible. Swing-out coolers further simply clean-out.
6. Standard reversing fan back-blows cooler cores to reduce debris buildup and help increase uptime.



4



5



6

670G LC

Engine	670G LC		
Manufacturer and Model	Isuzu 6WG1-iT4		
Non-Road Emissions Standard	EPA Interim Tier 4/EU Stage IIIB		
Net Rated Power (ISO 9249)	345 kW (463 hp) at 1,800 rpm		
Cylinders	6		
Displacement	15.7 L (957 cu. in.)		
Off-Level Capacity	70% (35 deg.)		
Aspiration	Turbocharged, air-to-air charge-air cooler		
Cooling			
2 cool-on-demand hydraulic-driven, suction-type fans with remote-mounted drives			
Powertrain			
2-speed propel with Autoshift			
Maximum Travel Speed			
Low	3.6 km/h (2.2 mph)		
High	5.2 km/h (3.2 mph)		
Drawbar Pull	46 115 kg (101,666 lb.)		
Hydraulics			
Open center, load sensing			
Main Pumps	2 variable-displacement pumps		
Maximum Rated Flow	489 L/m (129 gpm) x 2		
Pilot Pump	One gear		
Maximum Rated Flow	30 L/m (7.9 gpm)		
Pressure Setting	3900 kPa (566 psi)		
System Operating Pressure			
Circuits			
Implement	31 900 kPa (4,627 psi)		
Travel	34 300 kPa (4,975 psi)		
Swing	29 400 kPa (4,264 psi)		
Power Boost	34 300 kPa (4,975 psi)		
Controls	Pilot levers, short stroke, low-effort hydraulic pilot controls with shutoff lever		
Cylinders			
Heat-treated, chrome-plated, polished cylinder rods; hardened steel (replaceable bushings) pivot pins			
	<i>Bore</i>	<i>Rod Diameter</i>	<i>Stroke</i>
Boom (2)	191 mm (7.5 in.)	130 mm (5.1 in.)	1806 mm (71 in.)
Arm (1)	201 mm (7.9 in.)	140 mm (5.5 in.)	2164 mm (85 in.)
Bucket (1)	180 mm (7.1 in.)	130 mm (5.1 in.)	1555 mm (61 in.)
Electrical			
Number of Batteries (12 volt)	2		
Battery Capacity	500 CCA		
Alternator Rating	50 amp		
Work Lights	5 halogen (one mounted on frame, 2 mounted on boom, and 2 mounted on top of cab)		
Undercarriage			
Rollers (each side)			
Carrier	3		
Track	8		
Shoes, Double-Bar Grousers (each side)	47		
Track			
Adjustment	Hydraulic		
Guides	Front and center		
Chain	Sealed and lubricated		
Ground Pressure			
Double-Bar Grouser Shoes			
650 mm (26 in.)	93.8 kPa (13.6 psi)		
750 mm (30 in.)	82.7 kPa (12.0 psi)		
900 mm (36 in.)	69.6 kPa (10.1 psi)		



Swing Mechanism	670G LC
Speed	9.1 rpm
Torque	194 000 Nm (143,087 lb.-ft.)

Serviceability

Refill Capacities	
Fuel Tank	900 L (238 gal.)
Cooling System	70 L (18.5 gal.)
Engine Oil with Filter	57 L (15.1 gal.)
Hydraulic Tank	380 L (100.4 gal.)
Hydraulic System	750 L (198.1 gal.)
Gearbox	
Swing (each)	10.5 L (11.1 qt.)
Travel (each)	16 L (16.9 qt.)
Pump Drive	6.2 L (6.6 qt.)

Operating Weights

With full fuel tank; 79-kg (175 lb.) operator; 3.09-m³ (4.04 cu. yd.), 1370-mm (54 in.), 3126-kg (6,892 lb.) bucket; 4.2-m (13 ft. 9 in.) arm; 10 400-kg (22,928 lb.) counterweight; and 900-mm (36 in.) double-bar grouser shoes

SAE Operating Weight	71 688 kg (158,045 lb.)
----------------------	-------------------------

Component Weights

Undercarriage with Double-Bar Grouser Shoes	
650 mm (26 in.)	26 620 kg (58,687 lb.)
750 mm (30 in.)	27 240 kg (60,054 lb.)
900 mm (36 in.)	28 180 kg (62,126 lb.)
One-Piece Boom (with arm cylinder)	
7.8 m (25 ft. 7 in.)	6550 kg (14,440 lb.)
6.8-m (22 ft. 4 in.) Mass Excavating	6110 kg (13,470 lb.)
Arm with Bucket Cylinder and Linkage	
3.6 m (11 ft. 10 in.)	3620 kg (7,981 lb.)
4.2 m (13 ft. 9 in.)	3930 kg (8,664 lb.)
5.3 m (17 ft. 5 in.)	3620 kg (7,981 lb.)
2.9-m (9 ft. 6 in.) Mass Excavating	3820 kg (8,422 lb.)
Boom-Lift Cylinders (2), Total Weight	1110 kg (2,447 lb.)
3.09-m ³ (4.04 cu. yd.), 1370-mm (54 in.) Heavy-Duty High-Capacity Bucket	3126 kg (6,892 lb.)
Counterweight, Standard	10 400 kg (22,928 lb.)

Operating Dimensions

Arm Length	3.6 m (11 ft. 10 in.) w/ 7.8-m (25 ft. 7 in.) Boom	4.2 m (13 ft. 9 in.) w/ 7.8-m (25 ft. 7 in.) Boom	5.3 m (17 ft. 5 in.) w/ 7.8-m (25 ft. 7 in.) Boom	2.9-m (9 ft. 6 in.) Mass Excavating w/ 6.8-m (22 ft. 4 in.) Mass-Excavating Boom
Arm Digging Force				
SAE	247 kN (55,528 lb.)	224 kN (50,357 lb.)	192 kN (43,163 lb.)	297 kN (66,768 lb.)
ISO	255 kN (57,326 lb.)	231 kN (51,931 lb.)	196 kN (44,063 lb.)	306 kN (68,792 lb.)
Bucket Digging Force				
SAE	290 kN (65,195 lb.)	290 kN (65,195 lb.)	245 kN (55,078 lb.)	332 kN (74,637 lb.)
ISO	324 kN (72,838 lb.)	324 kN (72,838 lb.)	277 kN (62,272 lb.)	369 kN (82,954 lb.)
Lifting Capacity Over Front at Ground Level 9.0-m (30 ft.) Reach (with power boost)	15 211 kg (32,695 lb.)	15 300 kg (32,900 lb.)	15 522 kg (33,628 lb.)	15 190 kg (32,649 lb.)
A Maximum Reach	13.25 m (43 ft. 6 in.)	13.85 m (45 ft. 5 in.)	14.74 m (48 ft. 4 in.)	11.81 m (38 ft. 9 in.)
A' Maximum Reach at Ground Level	13.00 m (42 ft. 8 in.)	13.61 m (44 ft. 8 in.)	14.51 m (47 ft. 7 in.)	11.50 m (37 ft. 9 in.)
B Maximum Digging Depth	8.53 m (28 ft. 0 in.)	9.15 m (30 ft. 0 in.)	10.03 m (32 ft. 11 in.)	7.12 m (23 ft. 4 in.)
B' Maximum Digging Depth at 2.44-m (8 ft. 0 in.) Flat Bottom	8.40 m (27 ft. 7 in.)	9.03 m (29 ft. 8 in.)	9.92 m (32 ft. 7 in.)	6.97 m (22 ft. 10 in.)
C Maximum Cutting Height	11.92 m (39 ft. 1 in.)	12.24 m (40 ft. 2 in.)	12.65 m (41 ft. 6 in.)	11.90 m (39 ft. 1 in.)
D Maximum Dumping Height	8.05 m (26 ft. 5 in.)	8.33 m (27 ft. 4 in.)	9.17 m (30 ft. 1 in.)	7.33 m (24 ft. 1 in.)
E Minimum Swing Radius	5.78 m (19 ft. 0 in.)	5.76 m (18 ft. 11 in.)	5.60 m (18 ft. 4 in.)	5.24 m (17 ft. 2 in.)
F Maximum Vertical Wall	7.38 m (24 ft. 3 in.)	8.18 m (26 ft. 10 in.)	9.53 m (31 ft. 3 in.)	5.28 m (17 ft. 4 in.)
G Tail-Swing Radius	4.02 m (13 ft. 2 in.)	4.02 m (13 ft. 2 in.)	4.02 m (13 ft. 2 in.)	4.02 m (13 ft. 2 in.)

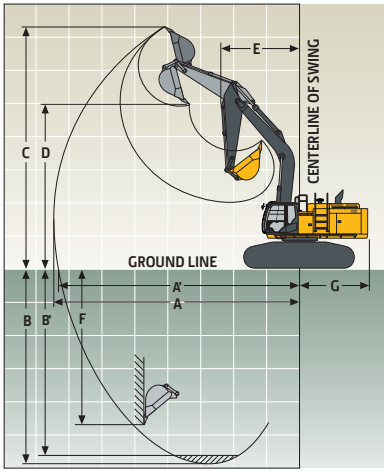

Machine Dimensions 670G LC

A Overall Length with Arm	
3.6 m (11 ft. 10 in.)	13.40 m (44 ft. 0 in.)
4.2 m (13 ft. 9 in.)	13.40 m (44 ft. 0 in.)
5.3 m (17 ft. 5 in.)	13.06 m (42 ft. 10 in.)
2.9-m (9 ft. 6 in.) Mass Excavating with Mass-Excavating Boom	12.42 m (40 ft. 9 in.)
B Overall Height with Arm	
3.6 m (11 ft. 10 in.)	4.46 m (14 ft. 8 in.)
4.2 m (13 ft. 9 in.)	4.98 m (16 ft. 4 in.)
5.3 m (17 ft. 5 in.)	5.28 m (17 ft. 4 in.)
2.9-m (9 ft. 6 in.) Mass Excavating with Mass-Excavating Boom	4.96 m (16 ft. 3 in.)
C Rear-End Length/Swing Radius	3.91 m (12 ft. 10 in.)
D Distance Between Idler/Sprocket Centerline	4.60 m (15 ft. 1 in.)
E Undercarriage Length	5.84 m (19 ft. 2 in.)
F Counterweight Clearance	1.53 m (5 ft. 0 in.)
G Upperstructure Width	4.09 m (13 ft. 5 in.)
H Cab Height	3.66 m (11 ft. 4 in.)
I Track Width with Double-Bar Grouser Shoes	650 mm (26 in.) / 750 mm (30 in.) / 900 mm (36 in.)
J Gauge Width	
Operating Position	3.30 m (10 ft. 10 in.)
Transport Position	2.82 m (9 ft. 3 in.)
K Ground Clearance	0.86 m (34 in.)
L Overall Width with 900-mm (36 in.) Double-Bar Grouser Shoes	
Operating Position	4.19 m (13 ft. 9 in.)
Transport Position	3.73 m (12 ft. 3 in.)

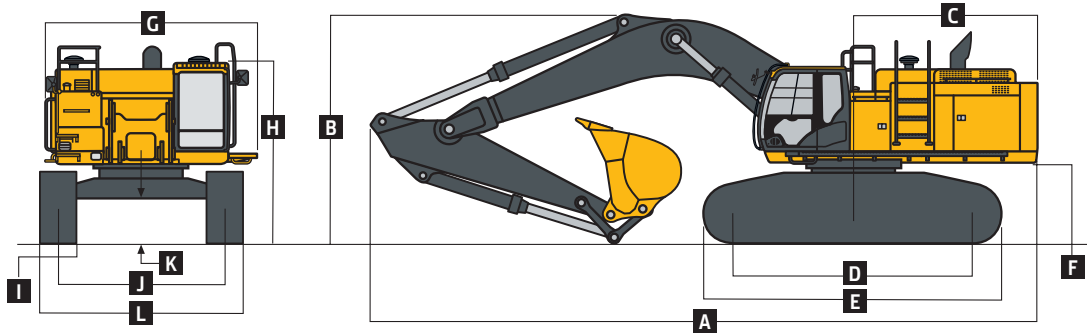

Packing Dimensions and Weights For Transportation

	Length	Height	Overall Width	Weight
Base Machine (without front attachment and side frame)*	5.22 m (17 ft. 2 in.)	3.32 m (10 ft. 11 in.)	3.39 m (11 ft. 1 in.)	20 100 kg (44,313 lb.)
Side Frame**				
650-mm (26 in.) Shoe Width	5.84 m (19 ft. 2 in.)	1.45 m (4 ft. 9 in.)	1.19 m (3 ft. 11 in.)	10 300 kg (22,708 lb.)
750-mm (30 in.) Shoe Width	5.84 m (19 ft. 2 in.)	1.45 m (4 ft. 9 in.)	1.24 m (4 ft. 1 in.)	10 600 kg (23,369 lb.)
900-mm (36 in.) Shoe Width	5.84 m (19 ft. 2 in.)	1.45 m (4 ft. 9 in.)	1.32 m (4 ft. 4 in.)	11 100 kg (24,471 lb.)
Counterweight, Standard	3.36 m (11 ft. 0 in.)	1.55 m (5 ft. 1 in.)	0.59 m (23 in.)	11 100 kg (24,471 lb.)
Boom				
6.8 m (22 ft. 4 in.)	7.14 m (23 ft. 5 in.)	2.51 m (8 ft. 3 in.)	1.39 m (4 ft. 7 in.)	6110 kg (13,470 lb.)
7.8 m (25 ft. 7 in.)	8.13 m (26 ft. 8 in.)	2.33 m (7 ft. 8 in.)	1.39 m (4 ft. 7 in.)	6550 kg (14,440 lb.)
Arm				
2.9 m (9 ft. 6 in.)	4.37 m (14 ft. 4 in.)	1.69 m (5 ft. 7 in.)	0.80 m (31 in.)	3620 kg (7,981 lb.)
3.6 m (11 ft. 10 in.)	5.11 m (16 ft. 9 in.)	1.44 m (4 ft. 9 in.)	0.80 m (31 in.)	3620 kg (7,981 lb.)
4.2 m (13 ft. 9 in.)	5.71 m (18 ft. 9 in.)	1.39 m (4 ft. 7 in.)	0.80 m (31 in.)	3930 kg (8,664 lb.)
5.3 m (17 ft. 1 in.)	6.73 m (22 ft. 1 in.)	1.26 m (4 ft. 2 in.)	0.80 m (31 in.)	3620 kg (7,981 lb.)
Less Arm and Counterweight	6.24 m (20 ft. 6 in.)	4.23 m (13 ft. 11 in.) / 3.76 m (12 ft. 4 in.) without exhaust stack	3.48 m (11 ft. 5 in.) with 650-mm (26 in.) shoes / 3.58 m (11 ft. 9 in.) with 750-mm (30 in.) shoes	42 900 kg (94,578 lb.) with 650-mm (26 in.) shoes / 43 300 kg (95,460 lb.) with 750-mm (30 in.) shoes

*Steps on the track frame and the side hydraulic oil tank, handrails on the upper battery box, upper fuel tank, and the side hydraulic oil tank must be removed to comply with the overall width dimensions above.

**The dimensions and the weights indicate those of one side frame.

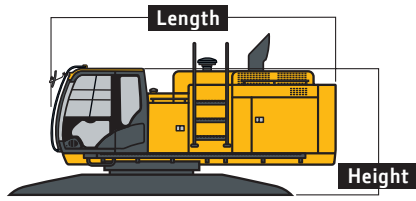

Base Machine

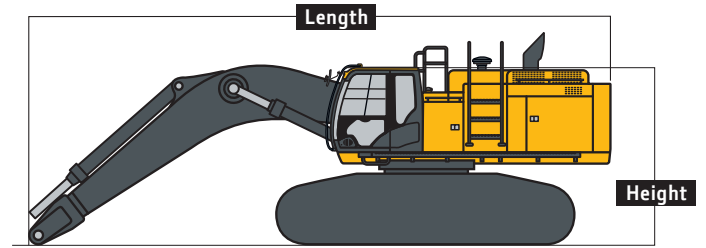

Less Counterweight and Arm

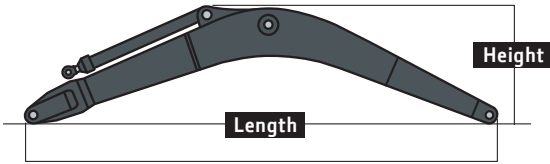

Boom

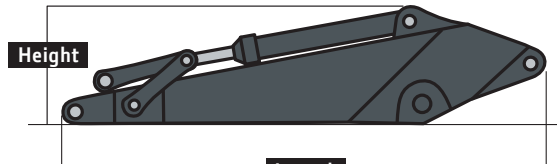

Arm

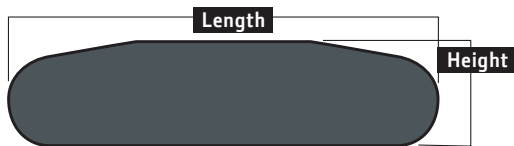

Side Frame

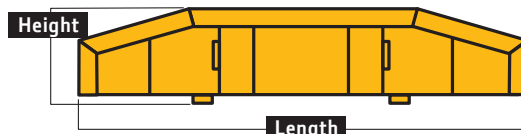

Counterweight

Lift Capacities

Boldface type indicates hydraulically limited capacity; lightface type indicates stability-limited capacities, in kg (lb.). Ratings at bucket lift hook; machine equipped with standard gauge and situated on firm, uniform supporting surface. Total load includes weight of cables, hook, etc. Figures do not exceed 87 percent of hydraulic capacities or 75 percent of weight needed to tip machine. All lift capacities are based on ISO 10567 (with power boost).

Load Point Height	3.0 m (10 ft.)		4.5 m (15 ft.)		6.0 m (20 ft.)		7.5 m (25 ft.)		9.0 m (30 ft.)		10.5 m (35 ft.)	
	Over Front	Over Side	Over Front	Over Side	Over Front	Over Side	Over Front	Over Side	Over Front	Over Side	Over Front	Over Side
<i>With 2.5-m³ (3.3 cu. yd.) bucket, 4.2-m (13 ft. 9 in.) arm, 7.8-m (25 ft. 7 in.) boom, and 650-mm (26 in.) double-bar grouser shoes</i>												
7.5 m (25 ft.)									10 877	10 877		
									(23,789)	(23,789)		
6.0 m (20 ft.)									11 695	11 695	10 074	8822
									(25,455)	(25,455)	(20,249)	(18,828)
4.5 m (15 ft.)					18 419	18 419	14 846	14 846	12 770	11 434	11 489	8600
					(39,595)	(39,595)	(32,081)	(32,081)	(27,710)	(24,562)	(25,022)	(18,394)
3.0 m (10 ft.)					21 775	21 060	16 786	14 767	13 935	10 914	12 146	8297
					(46,868)	(45,389)	(36,258)	(31,793)	(30,192)	(23,454)	(26,076)	(17,780)
1.5 m (5 ft.)					24 280	19 840	18 421	14 015	14 970	10 443	11 847	8011
					(52,394)	(42,717)	(39,817)	(30,161)	(32,415)	(22,442)	(25,435)	(17,176)
Ground Line			14 147	14 147	25 552	19 118	19 474	13 480	14 937	10 081	11 611	7789
			(32,798)	(32,798)	(55,264)	(41,112)	(42,128)	(28,992)	(32,099)	(21,662)	(24,941)	(16,710)
-1.5 m (-5 ft.)	10 795	10 795	19 888	19 888	25 665	18 795	19 742	13 178	14 702	9864	11 488	7673
	(24,434)	(24,434)	(45,601)	(45,601)	(55,570)	(40,387)	(42,409)	(28,333)	(31,598)	(21,196)	(24,701)	(16,485)
-3.0 m (-10 ft.)	17 778	17 778	27 898	27 898	24 708	18 764	19 274	13 097	14 647	9813		
	(40,167)	(40,167)	(63,882)	(63,882)	(53,469)	(40,316)	(41,640)	(28,162)	(31,502)	(21,107)		
-4.5 m (-15 ft.)	26 090	26 090	29 339	29 339	22 538	18 985	17 625	13 238	13 567	9987		
	(59,144)	(59,144)	(63,392)	(63,392)	(48,598)	(40,816)	(37,853)	(28,498)	(28,680)	(21,554)		
-6.0 m (-20 ft.)			23 967	23 967	18 551	18 551	13 914	13 697				
			(51,241)	(51,241)	(39,462)	(39,462)	(28,969)	(28,969)				

Lift Capacities (continued) 670G LC

Boldface type indicates hydraulically limited capacity; **lightface type** indicates stability-limited capacities, in kg (lb.). Ratings at bucket lift hook; machine equipped with standard gauge and situated on firm, uniform supporting surface. Total load includes weight of cables, hook, etc. Figures do not exceed 87 percent of hydraulic capacities or 75 percent of weight needed to tip machine. All lift capacities are based on ISO 10567 (with power boost).

Load Point Height	3.0 m (10 ft.)		4.5 m (15 ft.)		6.0 m (20 ft.)		7.5 m (25 ft.)		9.0 m (30 ft.)		10.5 m (35 ft.)	
Horizontal Distance from Centerline of Rotation	Over Front	Over Side	Over Front	Over Side	Over Front	Over Side	Over Front	Over Side	Over Front	Over Side	Over Front	Over Side
<i>With 3.5-m³ (4.6 cu. yd.) bucket, 2.9-m (9 ft. 6 in.) BE arm, 6.8-m (22 ft. 4 in.) BE boom, and 650-mm (26 in.) double-bar grouser shoes</i>												
7.5 m (25 ft.)							14 395	14 395				
							(31,612)	(31,612)				
6.0 m (20 ft.)					17 527	17 527	15 276	15 276				
					(37,885)	(37,885)	(33,224)	(33,224)				
4.5 m (15 ft.)					20 472	20 472	16 699	15 012	14 652	10 731		
					(44,111)	(44,111)	(36,197)	(32,260)	(31,942)	(22,921)		
3.0 m (10 ft.)					23 433	20 710	18 261	14 337	15 341	10 437		
					(50,516)	(44,580)	(39,522)	(30,822)	(32,915)	(22,377)		
1.5 m (5 ft.)					25 431	19 776	19 475	13 778	15 019	10 138		
					(54,940)	(42,529)	(42,140)	(29,614)	(32,245)	(21,754)		
Ground Line					26 021	19 288	19 945	13 427	14 832	9965		
					(56,317)	(41,441)	(43,040)	(28,854)	(31,876)	(21,412)		
-1.5 m (-5 ft.)			33 521	31 688	25 148	19 170	19 302	13 325				
			(72,778)	(67,856)	(54,427)	(41,173)	(41,640)	(28,645)				
-3.0 m (-10 ft.)	34 294	34 294	29 559	29 559	22 510	19 382	16 667	13 551				
	(77,983)	(77,983)	(63,977)	(63,977)	(48,496)	(41,653)	(35,284)	(29,217)				
-4.5 m (-15 ft.)			22 634	22 634	16 493	16 493						
			(48,277)	(48,277)	(34,298)	(34,298)						
<i>With 2.5-m³ (3.3 cu. yd.) bucket, 4.2-m (13 ft. 9 in.) arm, 7.8-m (25 ft. 7 in.) boom, and 750-mm (30 in.) double-bar grouser shoes</i>												
7.5 m (25 ft.)									10 877	10 877		
									(23,789)	(23,789)		
6.0 m (20 ft.)									11 695	11 695	10 074	8879
									(25,455)	(25,455)	(20,249)	(18,952)
4.5 m (15 ft.)					18 419	18 419	14 846	14 846	12 770	11 503	11 489	8657
					(39,595)	(39,595)	(32,081)	(32,081)	(27,710)	(24,712)	(25,022)	(18,518)
3.0 m (10 ft.)					21 775	21 178	16 786	14 854	13 935	10 983	12 146	8354
					(46,868)	(45,643)	(36,258)	(31,981)	(30,192)	(23,603)	(26,249)	(17,903)
1.5 m (5 ft.)					24 280	19 958	18 421	14 102	14 970	10 512	11 927	8068
					(52,394)	(42,971)	(39,817)	(30,349)	(32,415)	(22,591)	(25,608)	(17,300)
Ground Line			14 147	14 147	25 552	19 236	19 474	13 567	15 035	10 150	11 691	7846
			(32,798)	(32,798)	(55,264)	(41,112)	(42,128)	(28,992)	(32,311)	(21,662)	(25,114)	(16,710)
-1.5 m (-5 ft.)	10 795	10 795	19 888	19 888	25 665	18 912	19 798	13 265	14 800	9933	11 568	7730
	(24,434)	(24,434)	(45,601)	(45,601)	(55,570)	(40,642)	(42,681)	(28,521)	(31,810)	(21,346)	(24,874)	(16,608)
-3.0 m (-10 ft.)	17 778	17 778	27 898	27 898	24 708	18 882	19 274	13 184	14 745	9882		
	(40,167)	(40,167)	(63,882)	(63,882)	(53,469)	(40,570)	(41,640)	(28,350)	(31,713)	(21,256)		
-4.5 m (-15 ft.)	26 090	26 090	29 339	29 339	22 538	19 103	17 625	13 325	13 567	10 056		
	(59,144)	(59,144)	(63,392)	(63,392)	(48,598)	(41,070)	(37,853)	(28,686)	(28,680)	(21,703)		
-6.0 m (-20 ft.)			23 967	23 967	18 551	18 551	13 914	13 784				
			(51,241)	(51,241)	(39,462)	(39,462)	(28,969)	(28,969)				
<i>With 2.9-m³ (3.8 cu. yd.) bucket, 3.6-m (11 ft. 10 in.) arm, 7.8-m (25 ft. 7 in.) boom, and 900-mm (36 in.) double-bar grouser shoes</i>												
7.5 m (25 ft.)									11 737	11 737		
									(25,696)	(25,696)		
6.0 m (20 ft.)							13 984	13 984	12 459	11 908		
							(30,277)	(30,277)	(27,118)	(25,550)		
4.5 m (15 ft.)					19 903	19 903	15 769	15 613	13 440	11 455	12 043	8611
					(42,762)	(42,762)	(34,065)	(33,620)	(29,162)	(24,611)	(23,250)	(18,398)
3.0 m (10 ft.)					23 023	20 966	17 563	14 793	14 488	10 978	12 293	8368
					(49,548)	(45,200)	(37,932)	(31,856)	(31,388)	(23,595)	(26,380)	(17,930)
1.5 m (5 ft.)					25 061	19 939	18 974	14 126	15 369	10 560	12 038	8128
					(54,098)	(42,929)	(41,012)	(30,405)	(33,275)	(22,698)	(25,851)	(17,432)
Ground Line			12 940	12 940	25 788	19 410	19 740	13 687	15 211	10 260	11 861	7961
			(30,246)	(30,246)	(55,807)	(41,737)	(42,704)	(29,442)	(32,695)	(22,052)	(25,491)	(17,093)
-1.5 m (-5 ft.)			21 022	21 022	25 394	19 236	19 730	13 479	15 050	10 111		
			(48,226)	(48,226)	(55,010)	(41,334)	(42,682)	(28,984)	(32,358)	(21,738)		
-3.0 m (-10 ft.)	20 323	20 323	31 007	31 007	23 941	19 319	18 793	13 487	14 834	10 147		
	(45,939)	(45,939)	(67,288)	(67,288)	(51,811)	(41,514)	(40,564)	(29,012)	(31,798)	(21,850)		
-4.5 m (-15 ft.)	30 660	30 660	27 015	27 015	21 158	19 649	16 490	13 739				
	(69,671)	(69,671)	(58,346)	(58,346)	(45,545)	(42,258)	(35,230)	(29,603)				
-6.0 m (-20 ft.)			20 645	20 645	16 030	16 030						
			(43,853)	(43,853)	(33,647)	(33,647)						

Lift Capacities (continued) 670G LC

Boldface type indicates hydraulically limited capacity; lightface type indicates stability-limited capacities, in kg (lb.). Ratings at bucket lift hook; machine equipped with standard gauge and situated on firm, uniform supporting surface. Total load includes weight of cables, hook, etc. Figures do not exceed 87 percent of hydraulic capacities or 75 percent of weight needed to tip machine. All lift capacities are based on ISO 10567 (with power boost).

Load Point Height	3.0 m (10 ft.)		4.5 m (15 ft.)		6.0 m (20 ft.)		7.5 m (25 ft.)		9.0 m (30 ft.)		10.5 m (35 ft.)	
	Over Front	Over Side	Over Front	Over Side	Over Front	Over Side	Over Front	Over Side	Over Front	Over Side	Over Front	Over Side

With 2.5-m³ (3.3 cu. yd.) bucket, 4.2-m (13 ft. 9 in.) arm, 7.8-m (25 ft. 7 in.) boom, and 900-mm (36 in.) double-bar grouser shoes

7.5 m (25 ft.)									10 880	10 880		
									(23,800)	(23,800)		
6.0 m (20 ft.)									11 700	11 700	10 070	9030
									(25,500)	(25,500)	(20,300)	(19,300)
4.5 m (15 ft.)					18 420	18 420	14 850	14 850	12 770	11 690	11 490	8810
					(39,600)	(39,600)	(32,100)	(32,100)	(27,700)	(25,100)	(22,500)	(18,900)
3.0 m (10 ft.)					21 780	21 500	16 790	15 090	13 940	11 170	12 150	8510
					(46,900)	(46,300)	(36,300)	(32,500)	(30,200)	(24,000)	(26,400)	(18,200)
1.5 m (5 ft.)					24 280	20 280	18 420	14 340	14 970	10 700	12 140	8220
					(52,400)	(43,700)	(39,800)	(30,900)	(32,400)	(23,000)	(26,100)	(17,600)
Ground Line			14 150	14 150	25 550	19 560	19 470	13 800	15 300	10 340	11 900	8000
			(32,800)	(32,800)	(55,300)	(42,100)	(42,100)	(29,700)	(32,900)	(22,200)	(25,600)	(17,200)
-1.5 m (-5 ft.)	10 800	10 800	19 890	19 890	25 670	19 230	19 800	13 500	15 060	10 120	11 780	7890
	(24,400)	(24,400)	(45,600)	(45,600)	(55,600)	(41,300)	(42,800)	(29,000)	(32,400)	(21,800)	(25,300)	(16,900)
-3.0 m (-10 ft.)	17 780	17 780	27 900	27 900	24 710	19 200	19 270	13 420	15 010	10 070		
	(40,200)	(40,200)	(63,900)	(63,900)	(53,500)	(41,300)	(41,600)	(28,900)	(32,300)	(21,700)		
-4.5 m (-15 ft.)	26 090	26 090	29 340	29 340	22 540	19 420	17 630	13 560	13 570	10 240		
	(59,100)	(59,100)	(63,400)	(63,400)	(48,600)	(41,800)	(37,900)	(29,200)	(28,700)	(22,100)		
-6.0 m (-20 ft.)			23 970	23 970	18 550	18 550	13 910	13 910				
			(51,200)	(51,200)	(39,500)	(39,500)	(29,000)	(29,000)				

With 2.0-m³ (2.6 cu. yd.) bucket, 5.3-m (17 ft. 5 in.) arm, 7.8-m (25 ft. 7 in.) boom, and 900-mm (36 in.) double-bar grouser shoes

9.0 m (30 ft.)											6009	6009
											(11,573)	(11,573)
7.5 m (25 ft.)											7633	7633
											(16,037)	(16,037)
6.0 m (20 ft.)									9950	9950	8901	8901
									(21,588)	(21,588)	(18,979)	(18,979)
4.5 m (15 ft.)							13 443	13 443	11 864	11 864	10 429	9496
							(29,087)	(29,087)	(25,768)	(25,768)	(22,249)	(20,365)
3.0 m (10 ft.)			27 858	27 858	19 701	19 701	15 613	15 613	13 211	11 922	11 668	9138
			(59,723)	(59,723)	(42,441)	(42,441)	(33,756)	(33,756)	(28,648)	(25,636)	(25,370)	(19,608)
1.5 m (5 ft.)			17 982	17 982	22 902	21 457	17 611	15 185	14 493	11 368	12 479	8786
			(42,685)	(42,685)	(49,431)	(46,208)	(38,090)	(32,691)	(31,408)	(24,446)	(27,092)	(18,859)
Ground Line			16 168	16 168	25 049	20 401	19 134	14 486	15 522	10 905	12 398	8485
			(37,320)	(37,320)	(54,167)	(43,894)	(41,411)	(31,172)	(33,628)	(23,447)	(26,642)	(18,217)
-1.5 m (-5 ft.)	10 052	10 052	18 748	18 748	26 037	19 791	20 004	14 018	15 526	10 574	12 169	8269
	(22,701)	(22,701)	(42,960)	(42,960)	(56,367)	(42,552)	(43,307)	(30,154)	(33,379)	(22,735)	(26,160)	(17,762)
-3.0 m (-10 ft.)	14 711	14 711	23 606	23 606	25 938	19 532	20 117	13 777	15 333	10 396	12 064	8170
	(33,198)	(33,198)	(53,968)	(53,968)	(56,149)	(41,985)	(43,523)	(29,635)	(32,975)	(22,359)	(25,958)	(17,572)
-4.5 m (-15 ft.)	20 335	20 335	30 826	30 826	24 730	19 554	19 330	13 751	15 326	10 389		
	(46,013)	(46,013)	(70,608)	(68,371)	(53,432)	(42,044)	(41,701)	(29,595)	(32,988)	(22,372)		
-6.0 m (-20 ft.)	27 672	27 672	29 088	29 088	22 149	19 843	17 275	13 957	13 248	10 618		
	(62,903)	(62,903)	(62,555)	(62,555)	(47,558)	(42,706)	(36,921)	(30,084)	(27,798)	(22,951)		
-7.5 m (-25 ft.)			22 773	22 773	17 355	17 355						
			(48,117)	(48,117)	(36,413)	(36,413)						

With 3.5-m³ (4.6 cu. yd.) bucket, 2.9-m (9 ft. 6 in.) BE arm, 6.8-m (22 ft. 4 in.) BE boom, and 900-mm (36 in.) double-bar grouser shoes

7.5 m (25 ft.)							14 395	14 395				
							(31,612)	(31,612)				
6.0 m (20 ft.)					17 527	17 527	15 276	15 276				
					(37,885)	(37,885)	(33,224)	(33,224)				
4.5 m (15 ft.)					20 472	20 472	16 699	15 334	14 652	10 986		
					(44,111)	(44,111)	(36,197)	(32,957)	(31,942)	(23,474)		
3.0 m (10 ft.)					23 433	21 147	18 261	14 660	15 368	10 693		
					(50,516)	(45,523)	(39,522)	(31,520)	(33,393)	(22,931)		
1.5 m (5 ft.)					25 431	20 214	19 475	14 101	15 377	10 394		
					(54,940)	(43,472)	(42,140)	(30,312)	(33,018)	(22,308)		
Ground Line					26 021	19 726	19 945	13 750	15 190	10 220		
					(56,317)	(42,385)	(43,144)	(29,551)	(32,649)	(21,965)		
-1.5 m (-5 ft.)			33 521	32 367	25 148	19 608	19 302	13 648				
			(72,778)	(69,314)	(54,427)	(42,117)	(41,640)	(29,342)				
-3.0 m (-10 ft.)	34 294	34 294	29 559	29 559	22 510	19 819	16 667	13 874				
	(77,983)	(77,983)	(63,977)	(63,977)	(48,496)	(42,597)	(35,284)	(29,914)				
-4.5 m (-15 ft.)			22 634	22 634	16 493	16 493						
			(48,277)	(48,277)	(34,298)	(34,298)						

Buckets 670G LC

A full line of buckets is offered to meet a wide variety of applications. Digging forces are with power boost. Tooth selection includes the John Deere Fanggs™ Standard, Tiger, Twin Tiger, Abrasion panel, or Flare tooth. Replaceable cutting edges and a variety of teeth are available through John Deere Parts. Optional side cutters add 150 mm (6 in.) to bucket widths. Capacities are SAE heaped ratings.

Type Bucket	Bucket Width		Bucket Capacity		Bucket Weight		Bucket Dig Force (SAE)		Bucket Dig Force (ISO)		Arm Dig Force 3.6 m (11 ft. 10 in.) (SAE)		Arm Dig Force 3.6 m (11 ft. 10 in.) (ISO)	
	mm	in.	m ³	cu. yd.	kg	lb.	kN	lb.	kN	lb.	kN	lb.	kN	lb.
Extreme Duty Plate Lip	1219	48	2.65	3.5	3396	7,487	275	61,851	307	69,102	242	54,423	250	56,186
Extreme Duty Plate Lip	1370	54	3.06	4.0	3546	7,817	275	61,851	307	69,102	242	54,423	250	56,186
Extreme Duty Plate Lip	1524	60	3.53	4.6	3795	8,368	275	61,851	307	69,102	242	54,423	250	56,186
Heavy Duty High Capacity	914	36	1.80	2.4	2664	5,873	275	61,851	307	69,102	242	54,423	250	56,186
Heavy Duty High Capacity	1067	42	2.22	2.9	2867	6,320	275	61,851	307	69,102	242	54,423	250	56,186
Heavy Duty High Capacity	1219	48	2.06	2.7	2966	6,540	275	61,851	307	69,102	242	54,423	250	56,186
Heavy Duty High Capacity	1370	54	3.09	4.0	3129	6,898	275	61,851	307	69,102	242	54,423	250	56,186
Heavy Duty High Capacity	1524	60	3.54	4.6	3302	7,280	275	61,851	307	69,102	242	54,423	250	56,186
Heavy Duty High Capacity	1829	72	4.44	5.8	3593	7,921	275	61,851	307	69,102	242	54,423	250	56,186
Heavy Duty High Capacity	2032	80	5.05	6.6	3916	8,634	275	61,851	307	69,102	242	54,423	250	56,186
Heavy Capacity Dirt	2184	86	4.59	6.0	3941	8,688	287	64,421	320	71,973	246	55,278	254	57,069
Heavy Duty	914	36	1.30	1.7	2252	4,964	326	73,327	364	81,924	258	57,940	266	59,817
Heavy Duty	1067	42	1.58	2.1	2594	5,719	326	73,327	364	81,924	258	57,940	266	59,817
Heavy Duty	1219	48	1.90	2.5	2722	6,000	326	73,327	364	81,924	258	57,940	266	59,817
Heavy Duty	1370	54	2.19	2.9	2858	6,302	326	73,327	364	81,924	258	57,940	266	59,817
Heavy Duty	1524	60	2.52	3.3	3062	6,750	326	73,327	364	81,924	258	57,940	266	59,817
Truck Loading	1930	76	3.75	4.9	3043	6,709	287	64,421	320	71,973	246	55,278	254	57,069
Truck Loading	2083	82	4.05	5.3	3292	7,257	287	64,421	320	71,973	246	55,278	254	57,069

Bucket Selection Guide*

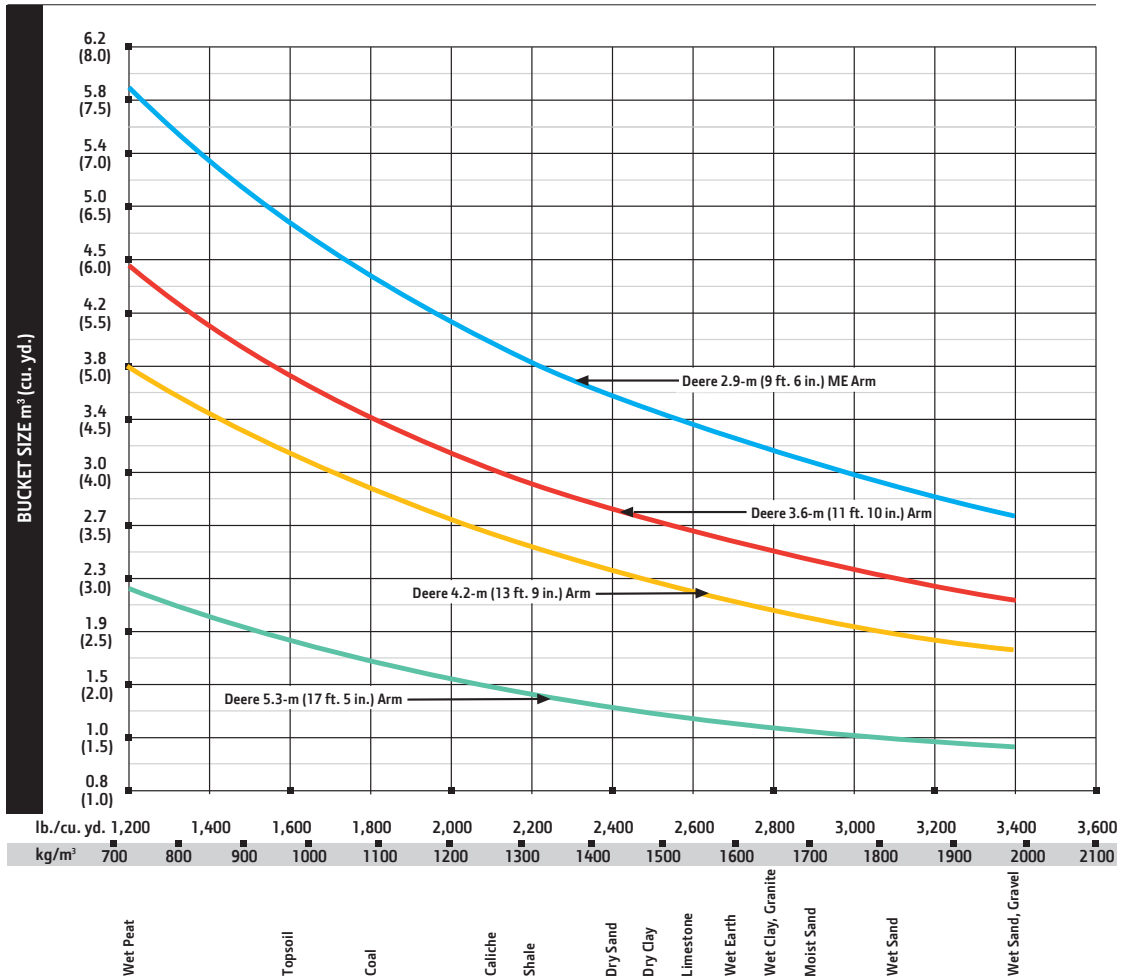

*Contact your John Deere dealer for optimum bucket and attachment selections. These recommendations are for general conditions and average use. Does not include optional equipment such as thumbs or couplers. Larger buckets may be possible when using light materials, for flat and level operations, less compacted materials, and volume loading applications such as mass excavation applications in ideal conditions. Smaller buckets are recommended for adverse conditions such as off-level applications, rocks, and uneven surfaces. Bucket capacity indicated is SAE heaped.

Arm Dig Force 4.2 m (13 ft. 9 in.) (SAE)		Arm Dig Force 4.2 m (13 ft. 9 in.) (ISO)		Arm Dig Force 5.3 m (17 ft. 5 in.) (SAE)		Arm Dig Force 5.3 m (17 ft. 5 in.) (ISO)		ME Arm Dig Force 2.9 m (9 ft. 6 in.) (SAE)		ME Arm Dig Force 2.9 m (9 ft. 6 in.) (ISO)		Bucket Tip Radius		Number of Teeth
kN	lb.	kN	lb.	kN	lb.	kN	lb.	kN	lb.	kN	lb.	mm	in.	
220	49,448	227	50,993	189	42,497	193	43,383	290	65,260	299	67,238	2281	89.79	3
220	49,448	227	50,993	189	42,497	193	43,383	290	65,260	299	67,238	2281	89.79	3
220	49,448	227	50,993	189	42,497	193	43,383	290	65,260	299	67,238	2281	89.79	3
220	49,448	227	50,993	189	42,497	193	43,383	290	65,260	299	67,238	2281	89.79	3
220	49,448	227	50,993	189	42,497	193	43,383	290	65,260	299	67,238	2281	89.79	3
220	49,448	227	50,993	189	42,497	193	43,383	290	65,260	299	67,238	2281	89.79	4
220	49,448	227	50,993	189	42,497	193	43,383	290	65,260	299	67,238	2281	89.79	5
220	49,448	227	50,993	189	42,497	193	43,383	290	65,260	299	67,238	2281	89.79	5
220	49,448	227	50,993	189	42,497	193	43,383	290	65,260	299	67,238	2281	89.79	6
220	49,448	227	50,993	189	42,497	193	43,383	290	65,260	299	67,238	2281	89.79	6
223	50,152	230	51,720	58	13,013	195	43,910	295	66,427	304	68,440	2190	86.23	6
233	52,331	240	53,996	198	44,597	203	45,526	312	70,090	321	72,214	1924	75.75	3
233	52,331	240	53,996	198	44,597	203	45,526	312	70,090	321	72,214	1924	75.75	4
233	52,331	240	53,996	198	44,597	203	45,526	312	70,090	321	72,214	1924	75.75	4
233	52,331	240	53,996	198	44,597	203	45,526	312	70,090	321	72,214	1924	75.75	5
233	52,331	240	53,996	198	44,597	203	45,526	312	70,090	321	72,214	1924	75.75	5
223	50,152	230	51,720	58	13,013	195	43,910	295	66,427	304	68,440	2189	86.20	6
223	50,152	230	51,720	58	13,013	195	43,910	295	66,427	304	68,440	2189	86.20	7

870G LC



Engine		870G LC	
Manufacturer and Model	Isuzu 6WG1-iT4		
Non-Road Emissions Standard	EPA Interim Tier 4/EU Stage IIIB		
Net Rated Power (ISO 9249)	397 kW (532 hp) at 1,800 rpm		
Cylinders	6		
Displacement	15.7 L (957 cu. in.)		
Off-Level Capacity	70% (35 deg.)		
Aspiration	Turbocharged, air-to-air charge-air cooler		
Cooling			
Cool-on-demand hydraulic-driven, suction-type fan with remote-mounted drive			
Powertrain			
2-speed propel with Autoshift			
Maximum Travel Speed			
Low	3.2 km/h (2.0 mph)		
High	4.7 km/h (2.9 mph)		
Drawbar Pull	57 240 kg (126,193 lb.)		
Hydraulics			
Open center, load sensing			
Main Pumps		2 variable-displacement pumps	
Maximum Rated Flow	566 L/m (150 gpm) x 2		
Pilot Pump		One gear	
Maximum Rated Flow	30 L/m (7.9 gpm)		
Pressure Setting	3900 kPa (566 psi)		
System Operating Pressure			
Circuits			
Implement	31 900 kPa (4,627 psi)		
Travel	34 300 kPa (4,975 psi)		
Swing	29 400 kPa (4,264 psi)		
Power Boost	34 300 kPa (4,975 psi)		
Controls		Pilot levers, short stroke, low-effort hydraulic pilot controls with shutoff lever	
Cylinders			
Heat-treated, chrome-plated, polished cylinder rods; hardened steel (replaceable bushings) pivot pins			
	<i>Bore</i>	<i>Rod Diameter</i>	<i>Stroke</i>
Boom (2)	215 mm (8.5 in.)	150 mm (5.9 in.)	1835 mm (72.2 in.)
Arm (1)	225 mm (8.9 in.)	160 mm (6.3 in.)	2225 mm (87.6 in.)
Bucket (1)	200 mm (7.9 in.)	140 mm (5.5 in.)	1555 mm (61.2 in.)
Electrical			
Number of Batteries (12 volt)	2		
Battery Capacity	500 CCA		
Alternator Rating	50 amp		
Work Lights	5 halogen (one mounted on frame, 2 mounted on boom, and 2 mounted on top of cab)		
Undercarriage			
Rollers (each side)			
Carrier	3		
Track	9		
Shoes, Double-Bar Grousers (each side)	51		
Track			
Adjustment	Hydraulic		
Guides	Front and center		
Chain	Sealed and lubricated		
Ground Pressure			
Double-Bar Grouser Shoes			
650 mm (26 in.)	115.3 kPa (16.7 psi)		
750 mm (30 in.)	100.7 kPa (14.6 psi)		
900 mm (36 in.)	84.8 kPa (12.3 psi)		
1020 mm (40 in.)	77.2 kPa (11.2 psi)		



Swing Mechanism	870G LC
Speed	7.8 rpm
Torque	267 000 Nm (196,929 lb.-ft.)

Serviceability

Refill Capacities	
Fuel Tank	1110 L (293 gal.)
Cooling System	112 L (29.6 gal.)
Engine Oil with Filter	57 L (15.1 gal.)
Hydraulic Tank	500 L (132.1 gal.)
Hydraulic System	1042 L (275.3 gal.)
Gearbox	
Swing (each)	15 L (15.9 qt.)
Travel (each)	19 L (20.1 qt.)
Pump Drive	6.2 L (6.6 qt.)

Operating Weights

With full fuel tank; 79-kg (175 lb.) operator; 3.49-m³ (4.57 cu. yd.), 1370-mm (54 in.), 3558-kg (7,844 lb.) bucket; 4.4-m (14 ft. 5 in.) arm; 13 300-kg (29,321 lb.) counterweight; and 900-mm (36 in.) double-bar grouser shoes

SAE Operating Weight	87 659 kg (193,255 lb.)
----------------------	-------------------------

Component Weights

Undercarriage with Double-Bar Grouser Shoes	
650 mm (26 in.)	32 350 kg (71,320 lb.)
750 mm (30 in.)	33 050 kg (72,863 lb.)
900 mm (36 in.)	33 990 kg (74,935 lb.)
1020 mm (40 in.)	34 420 kg (75,883 lb.)
One-Piece Boom (with arm cylinder)	
8.4 m (27 ft. 7 in.)	8200 kg (18,078 lb.)
7.1-m (23 ft. 4 in.) Mass Excavating	7670 kg (16,909 lb.)
10.0 m (32 ft. 10 in.)	9390 kg (20,701 lb.)
Arm with Bucket Cylinder and Linkage	
3.7 m (12 ft. 1 in.)	4330 kg (9,546 lb.)
4.4 m (14 ft. 5 in.)	4660 kg (10,274 lb.)
5.4 m (17 ft. 9 in.)	4950 kg (10,913 lb.)
2.95-m (9 ft. 8 in.) with 7.1-m (23 ft. 4 in.) Mass-Excavating Boom	4650 kg (10,251 lb.)
Boom-Lift Cylinders (2), Total Weight	
3.49-m ³ (4.57 cu. yd.), 1370-mm (54 in.)	1700 kg (3,748 lb.)
Heavy-Duty High-Capacity Bucket	3558 kg (7,844 lb.)
Counterweight, Standard	13 300 kg (29,321 lb.)

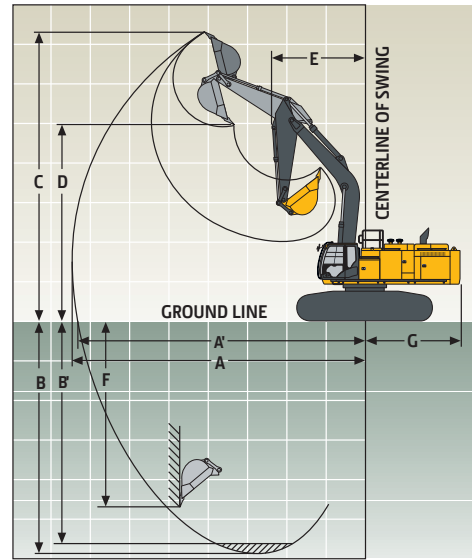

Operating Dimensions

Arm Length	3.7 m (12 ft. 2 in.) w/ 8.4-m (27 ft. 7 in.) Boom	4.4 m (14 ft. 5 in.) w/ 8.4-m (27 ft. 7 in.) Boom	5.4 m (17 ft. 9 in.) w/ 8.4-m (27 ft. 7 in.) Boom	2.95-m (9 ft. 8 in.) w/ 7.1-m (23 ft. 4 in.) Mass-Excavating Boom	4.4-m (14 ft. 5 in.) w/ 10.0-m (32 ft. 10 in.) Boom	5.4-m (17 ft. 9 in.) w/ 10.0-m (32 ft. 10 in.) Boom
Arm Digging Force						
SAE	315 kN (70,815 lb.)	273 kN (61,373 lb.)	237 kN (53,280 lb.)	378 kN (84,978 lb.)	273 kN (61,373 lb.)	237 kN (53,280 lb.)
ISO	323 kN (72,613 lb.)	280 kN (62,946 lb.)	243 kN (54,629 lb.)	394 kN (88,575 lb.)	280 kN (62,946 lb.)	243 kN (54,629 lb.)
Bucket Digging Force						
SAE	359 kN (80,706 lb.)	359 kN (80,706 lb.)	289 kN (64,970 lb.)	411 kN (92,396 lb.)	359 kN (80,706 lb.)	289 kN (64,970 lb.)
ISO	399 kN (89,699 lb.)	399 kN (89,699 lb.)	323 kN (72,613 lb.)	472 kN (106,110 lb.)	399 kN (89,699 lb.)	323 kN (72,613 lb.)
Lifting Capacity Over Front at Ground Level						
9.0-m (30 ft.) Reach (with power boost)	20 579 kg (44,499 lb.)	20 260 kg (43,800 lb.)	19 466 kg (42,109 lb.)	20 609 kg (44,450 lb.)	18 919 kg (40,872 lb.)	18 341 kg (40,435 lb.)
A	Maximum Reach	14.10 m (46 ft. 3 in.)	14.91 m (48 ft. 11 in.)	15.91 m (52 ft. 2 in.)	12.34 m (40 ft. 6 in.)	16.55 m (54 ft. 4 in.)
A'	Maximum Reach at Ground Level	13.82 m (45 ft. 4 in.)	14.64 m (48 ft. 0 in.)	15.67 m (51 ft. 5 in.)	12.02 m (39 ft. 5 in.)	16.32 m (53 ft. 7 in.)
B	Maximum Digging Depth	8.87 m (29 ft. 1 in.)	9.57 m (31 ft. 5 in.)	10.57 m (34 ft. 8 in.)	7.14 m (23 ft. 5 in.)	11.16 m (36 ft. 7 in.)
B'	Maximum Digging Depth at 2.44-m (8 ft. 0 in.) Flat Bottom	8.74 m (28 ft. 8 in.)	9.46 m (31 ft. 0 in.)	10.46 m (34 ft. 4 in.)	7.00 m (23 ft. 0 in.)	11.04 m (36 ft. 3 in.)
C	Maximum Cutting Height	13.03 m (42 ft. 9 in.)	13.82 m (45 ft. 4 in.)	14.53 m (47 ft. 8 in.)	12.01 m (39 ft. 5 in.)	14.66 m (48 ft. 1 in.)
D	Maximum Dumping Height	9.08 m (29 ft. 9 in.)	9.73 m (31 ft. 11 in.)	10.41 m (34 ft. 2 in.)	8.13 m (26 ft. 8 in.)	10.81 m (35 ft. 6 in.)
E	Minimum Swing Radius	5.95 m (19 ft. 6 in.)	5.94 m (19 ft. 6 in.)	5.94 m (19 ft. 6 in.)	5.21 m (17 ft. 1 in.)	7.35 m (24 ft. 1 in.)
F	Maximum Vertical Wall	7.17 m (23 ft. 6 in.)	8.48 m (27 ft. 10 in.)	9.75 m (32 ft. 0 in.)	4.10 m (13 ft. 5 in.)	9.87 m (32 ft. 5 in.)
G	Tail-Swing Radius	4.60 m (15 ft. 1 in.)	4.60 m (15 ft. 1 in.)	4.60 m (15 ft. 1 in.)	4.60 m (15 ft. 1 in.)	4.60 m (15 ft. 1 in.)

Machine Dimensions 870G LC

A Overall Length with Arm	
3.7 m (12 ft. 2 in.)	14.88 m (48 ft. 10 in.)
4.4 m (14 ft. 5 in.)	14.80 m (48 ft. 7 in.)
5.4 m (17 ft. 9 in.)	14.65 m (48 ft. 1 in.)
2.95-m (9 ft. 8 in.) Mass Excavating with Mass-Excavating Boom	13.55 m (44 ft. 5 in.)
B Overall Height with Arm	
3.7 m (12 ft. 2 in.)	4.77 m (15 ft. 8 in.)
4.4 m (14 ft. 5 in.)	5.13 m (16 ft. 10 in.)
5.4 m (17 ft. 9 in.)	5.76 m (18 ft. 11 in.)
2.95-m (9 ft. 8 in.) Mass Excavating with Mass-Excavating Boom	5.20 m (17 ft. 1 in.)
C Rear-End Length/Swing Radius	4.54 m (14 ft. 11 in.)
D Distance Between Idler/Sprocket Centerline	5.11 m (16 ft. 9 in.)
E Undercarriage Length	6.36 m (20 ft. 10 in.)
F Counterweight Clearance	1.68 m (5 ft. 6 in.)
G Upperstructure Width	4.12 m (13 ft. 6 in.)
H Cab Height	3.69 m (12 ft. 1 in.)
I Track Width with Double-Bar Grouser Shoes	650 mm (26 in.) / 750 mm (30 in.) / 900 mm (36 in.) / 1020 mm (40 in.)
J Gauge Width	
Operating Position	3.45 m (11 ft. 4 in.)
Transport Position	2.83 m (9 ft. 3 in.)
K Ground Clearance	0.89 m (35 in.)
L Overall Width with 900-mm (36 in.) Double-Bar Grouser Shoes	
Operating Position	4.35 m (14 ft. 3 in.)
Transport Position	3.73 m (12 ft. 3 in.)

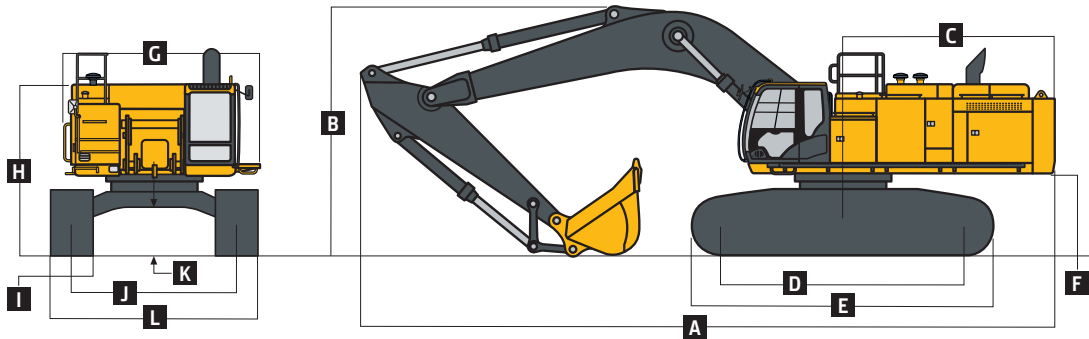

Packing Dimensions and Weights For Transportation

	Length	Height	Overall Width	Weight
Base Machine (without front attachment and side frame)*	6.04 m (19 ft. 10 in.)	3.49 m (11 ft. 5 in.)	3.39 m (11 ft. 1 in.)	27 400 kg (60,407 lb.)
Side Frame**				
650-mm (26 in.) Shoe Width	6.36 m (20 ft. 10 in.)	1.50 m (4 ft. 11 in.)	1.30 m (4 ft. 3 in.)	12 100 kg (26,676 lb.)
750-mm (30 in.) Shoe Width	6.36 m (20 ft. 10 in.)	1.50 m (4 ft. 11 in.)	1.33 m (4 ft. 4 in.)	12 500 kg (27,558 lb.)
900-mm (36 in.) Shoe Width	6.36 m (20 ft. 10 in.)	1.50 m (4 ft. 11 in.)	1.43 m (4 ft. 8 in.)	12 890 kg (28,418 lb.)
1020-mm (40 in.) Shoe Width	6.36 m (20 ft. 10 in.)	1.50 m (4 ft. 11 in.)	1.45 m (4 ft. 9 in.)	13 320 kg (29,366 lb.)
Counterweight, Standard	3.36 m (11 ft. 0 in.)	1.62 m (5 ft. 4 in.)	0.72 m (28 in.)	13 300 kg (29,321 lb.)
Boom				
7.1 m (23 ft. 4 in.)	7.49 m (24 ft. 7 in.)	2.70 m (8 ft. 10 in.)	1.45 m (4 ft. 9 in.)	7670 kg (16,909 lb.)
8.4 m (27 ft. 7 in.)	8.78 m (28 ft. 10 in.)	2.50 m (8 ft. 2 in.)	1.45 m (4 ft. 9 in.)	8200 kg (18,078 lb.)
10.0 m (32 ft. 10 in.)	10.37 m (34 ft. 0 in.)	2.70 m (8 ft. 10 in.)	1.45 m (4 ft. 9 in.)	9390 kg (20,701 lb.)
Arm				
2.95 m (9 ft. 8 in.)	4.46 m (14 ft. 8 in.)	1.66 m (5 ft. 5 in.)	0.85 m (33 in.)	4650 kg (10,251 lb.)
3.7 m (12 ft. 2 in.)	5.29 m (17 ft. 4 in.)	1.42 m (4 ft. 8 in.)	0.82 m (32 in.)	4330 kg (9,546 lb.)
4.4 m (14 ft. 5 in.)	5.88 m (19 ft. 3 in.)	1.42 m (4 ft. 8 in.)	0.82 m (32 in.)	4660 kg (10,274 lb.)
5.4 m (17 ft. 9 in.)	6.83 m (22 ft. 5 in.)	1.48 m (4 ft. 10 in.)	0.80 m (31 in.)	4950 kg (10,913 lb.)
Less Arm and Counterweight	7.08 m (23 ft. 3 in.)	4.41 m (14 ft. 6 in.) / 3.39 m (11 ft. 1 in.) without exhaust stack	3.60 m (11 ft. 10 in.)	51 800 kg (114,199 lb.) with 650-mm (26 in.) shoes / 52 500 kg (115,743 lb.) with 750-mm (30 in.) shoes

*Steps on the track frame and the side hydraulic oil tank, handrails on the upper battery box, upper fuel tank, and the side hydraulic oil tank must be removed to comply with the overall width dimensions above.

**The dimensions and the weights indicate those of one side frame.

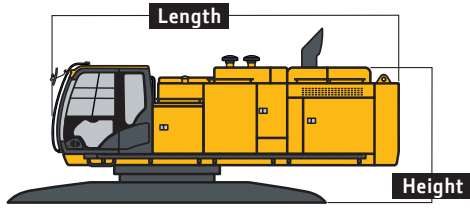

Base Machine

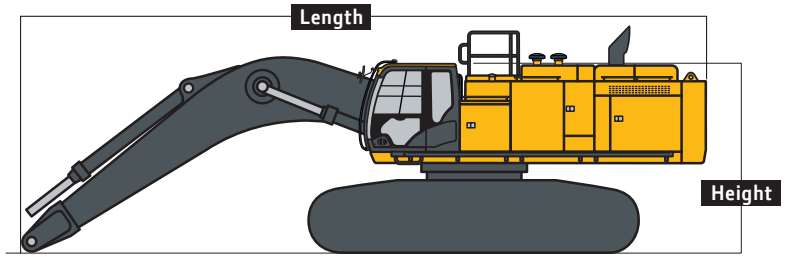

Less Counterweight and Arm

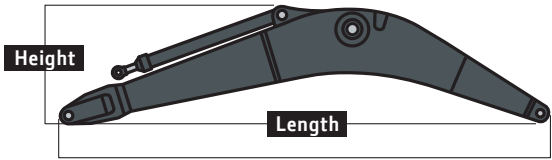

Boom

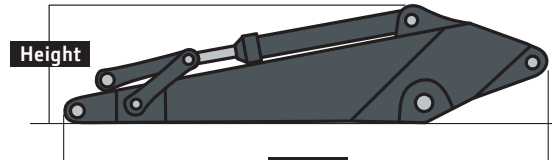

Arm



Side Frame

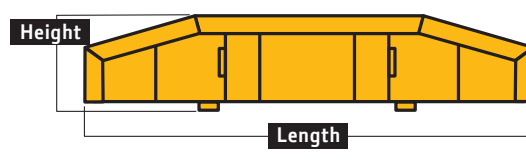

Counterweight

Lift Capacities

Boldface type indicates hydraulically limited capacity; lightface type indicates stability-limited capacities, in kg (lb.). Ratings at bucket lift hook; machine equipped with standard gauge and situated on firm, uniform supporting surface. Total load includes weight of cables, hook, etc. Figures do not exceed 87 percent of hydraulic capacities or 75 percent of weight needed to tip machine. All lift capacities are based on ISO 10567 (with power boost).

Load Point	3.0 m (10 ft.)		4.5 m (15 ft.)		6.0 m (20 ft.)		7.5 m (25 ft.)		9.0 m (30 ft.)		10.5 m (35 ft.)		12.0 m (40 ft.)	
Height	Over Front	Over Side	Over Front	Over Side	Over Front	Over Side	Over Front	Over Side	Over Front	Over Side	Over Front	Over Side	Over Front	Over Side
Horizontal Distance from Centerline of Rotation														
<i>With 2.9-m³ (3.79 cu. yd.) bucket, 4.4-m (14 ft. 5 in.) arm, 8.4-m (27 ft. 7 in.) boom, and 650-mm (26 in.) double-bar grouser shoes</i>														
9.0 m (30 ft.)											10 017 (19,446)	10 017 (19,446)		
7.5 m (25 ft.)									13 533 (29,445)	13 533 (29,445)	12 668 (26,635)	12 546 (26,635)		
6.0 m (20 ft.)							16 971 (36,623)	16 971 (36,623)	14 840 (32,179)	14 840 (32,179)	13 489 (29,365)	12 255 (26,246)	9301 (16,454)	9288 (16,454)
4.5 m (15 ft.)					25 251 (54,124)	25 251 (54,124)	19 607 (42,254)	19 607 (42,254)	16 415 (35,518)	15 519 (33,378)	14 422 (31,321)	11 822 (25,362)	11 997 (23,411)	9110 (19,434)
3.0 m (10 ft.)					29 592 (63,589)	28 023 (60,425)	22 176 (47,813)	19 817 (42,693)	18 010 (38,942)	14 781 (31,795)	15 403 (33,396)	11 363 (24,389)	13 674 (27,728)	8875 (18,968)
1.5 m (5 ft.)					28 893 (69,872)	26 575 (57,214)	24 195 (52,236)	18 846 (40,574)	19 362 (41,869)	14 143 (30,416)	16 260 (35,217)	10 951 (23,508)	13 846 (29,651)	8631 (18,483)
Ground Line					28 793 (68,029)	25 831 (55,531)	25 383 (54,873)	18 201 (39,155)	20 259 (43,815)	13 672 (29,394)	16 821 (36,393)	10 634 (22,832)	13 656 (26,766)	8454 (18,128)
-1.5 m (-5 ft.)			16 350 (37,551)	16 350 (37,551)	33 262 (72,025)	25,555 (54,895)	25 660 (55,505)	17 863 (38,407)	20 543 (44,412)	13 394 (28,791)	16 806 (36,123)	10 449 (22,446)		
-3.0 m (-10 ft.)	16 528 (37,406)	16 528 (37,406)	24 952 (57,056)	24 952 (57,056)	31 886 (69,029)	25 594 (54,968)	24 981 (53,997)	17 787 (38,243)	20 048 (43,253)	13 315 (28,633)	16 234 (34,820)	10 432 (22,447)		
-4.5 m (-15 ft.)	25 416 (57,577)	25 416 (57,577)	36 206 (81,680)	36 206 (81,680)	29 279 (63,219)	25 896 (55,642)	23 165 (49,890)	17 955 (38,630)	18 445 (39,501)	13 459 (28,987)				
-6.0 m (-20 ft.)			31 730 (68,104)	31 730 (68,104)	24 964 (53,446)	24 964 (53,446)	19 636 (41,734)	18 414 (39,695)						

Lift Capacities (continued) 870G LC

Boldface type indicates hydraulically limited capacity; **lightface type** indicates stability-limited capacities, in kg (lb.). Ratings at bucket lift hook; machine equipped with standard gauge and situated on firm, uniform supporting surface. Total load includes weight of cables, hook, etc. Figures do not exceed 87 percent of hydraulic capacities or 75 percent of weight needed to tip machine. All lift capacities are based on ISO 10567 (with power boost).

Load Point Height	3.0 m (10 ft.)		4.5 m (15 ft.)		6.0 m (20 ft.)		7.5 m (25 ft.)		9.0 m (30 ft.)		10.5 m (35 ft.)		12.0 m (40 ft.)	
Horizontal Distance from Centerline of Rotation	Over Front	Over Side	Over Front	Over Side	Over Front	Over Side	Over Front	Over Side	Over Front	Over Side	Over Front	Over Side	Over Front	Over Side
<i>With 4.5-m³ (5.89 cu. yd.) bucket, 2.95-m (9 ft. 8 in.) BE arm, 7.1-m (23 ft. 4 in.) BE boom, and 650-mm (26 in.) double-bar grouser shoes</i>														
7.5 m (25 ft.)							18 586	18 586						
							(40,535)	(40,535)						
6.0 m (20 ft.)					24 030	24 030	20 180	20 180	17 955	15 295				
					(51,762)	(51,762)	(43,741)	(43,741)	(39,197)	(32,640)				
4.5 m (15 ft.)					28 171	28 171	22 238	20 727	18 941	14 949				
					(60,565)	(60,565)	(48,083)	(44,569)	(41,121)	(32,000)				
3.0 m (10 ft.)					31 893	28 423	24 273	19 742	19 970	14 436				
					(68,676)	(61,194)	(52,446)	(42,457)	(43,285)	(30,974)				
1.5 m (5 ft.)					33 940	27 185	25 677	18 944	20 662	13 961				
					(73,303)	(58,454)	(55,503)	(40,722)	(44,705)	(29,963)				
Ground Line					34 060	26 550	26,028	18 430	20 609	13 643				
					(73,723)	(57,025)	(56,274)	(39,600)	(44,450)	(29,293)				
-1.5 m (-5 ft.)			37 404	37 404	32 417	26 358	24 990	18 223						
			(86,602)	(86,602)	(70,176)	(56,585)	(53,930)	(39,155)						
-3.0 m (-10 ft.)	37 120	37 120	37 087	37 087	28 747	26 539	21 817	18 368						
	(84,432)	(84,432)	(80,338)	(80,338)	(61,986)	(56,992)	(46,554)	(39,521)						
<i>With 2.9-m³ (3.79 cu. yd.) bucket, 4.4-m (14 ft. 5 in.) arm, 8.4-m (27 ft. 7 in.) boom, and 750-mm (30 in.) double-bar grouser shoes</i>														
9.0 m (30 ft.)											10 017	10 017		
											(19,446)	(19,446)		
7.5 m (25 ft.)									13 533	13 533	12 668	12 662		
									(29,445)	(29,445)	(26,635)	(26,635)		
6.0 m (20 ft.)							16 971	16 971	14 840	14 840	13 489	12 370	9301	9301
							(36,623)	(36,623)	(32,179)	(32,179)	(29,365)	(26,496)	(16,454)	(16,454)
4.5 m (15 ft.)					25 251	25 251	19 607	16 415	15 659	14 422	11 938	11 997	9209	9209
					(54,124)	(54,124)	(42,254)	(42,254)	(35,518)	(33,681)	(31,321)	(25,612)	(23,411)	(19,647)
3.0 m (10 ft.)					29 592	28 265	22 176	19 994	18 010	14 921	15 403	11 479	13 674	8974
					(63,589)	(60,945)	(47,813)	(43,076)	(38,942)	(32,097)	(33,396)	(24,639)	(27,728)	(19,181)
1.5 m (5 ft.)					28 893	26 816	24 195	19 023	19 362	14 283	16 260	11 066	13 991	8730
					(69,872)	(57,734)	(52,236)	(40,957)	(41,869)	(30,718)	(35,217)	(23,758)	(29,651)	(18,697)
Ground Line					28 793	26 072	25 383	18 378	20 259	13 812	16 821	10 750	13 801	8552
					(68,029)	(56,051)	(54,873)	(39,537)	(43,815)	(29,696)	(36,393)	(23,082)	(26,766)	(18,341)
-1.5 m (-5 ft.)			16 350	16 350	33 262	25 797	25 660	18 040	20 543	13 534	16 905	10 564		
			(37,551)	(37,551)	(72,025)	(55,415)	(55,505)	(38,790)	(44,412)	(29,094)	(36,496)	(22,696)		
-3.0 m (-10 ft.)	16 528	16 528	24 952	24 952	31 886	25 835	24 981	17 964	20 048	13 455	16 234	10 548		
	(37,406)	(37,406)	(57,056)	(57,056)	(69,029)	(55,489)	(53,997)	(38,625)	(43,253)	(28,936)	(34,820)	(22,697)		
-4.5 m (-15 ft.)	25 416	25 416	36 206	36 206	29 279	26 138	23 165	18 132	18 445	13 599				
	(57,577)	(57,577)	(81,680)	(81,680)	(63,219)	(56,162)	(49,890)	(39,012)	(39,501)	(29,289)				
-6.0 m (-20 ft.)			31 730	31 730	24 964	24 964	19 636	18 591						
			(68,104)	(68,104)	(53,446)	(53,446)	(41,734)	(40,078)						
<i>With 3.5-m³ (4.58 cu. yd.) bucket, 3.7-m (12 ft. 2 in.) arm, 8.4-m (27 ft. 7 in.) boom, and 900-mm (36 in.) double-bar grouser shoes</i>														
9.0 m (30 ft.)									13 883	13 883				
									(30,445)	(30,445)				
7.5 m (25 ft.)									14 650	14 650	13 097	12 403		
									(31,872)	(31,872)	(25,048)	(25,048)		
6.0 m (20 ft.)					22 867	22 867	18 428	18 428	15 885	15 885	14 331	12 206		
					(48,972)	(48,972)	(39,742)	(39,742)	(34,438)	(34,438)	(31,213)	(26,116)		
4.5 m (15 ft.)					27 613	27 613	20 981	20 942	17 362	15 521	15 159	11 849		
					(59,131)	(59,131)	(45,194)	(45,132)	(37,560)	(33,384)	(32,927)	(25,416)		
3.0 m (10 ft.)					31 519	27 885	23 337	19 847	18 811	14 858	16 005	11 450		
					(67,721)	(60,141)	(50,308)	(42,764)	(40,667)	(31,963)	(34,698)	(24,576)		
1.5 m (5 ft.)					25 408	25 408	25 009	19 031	19 954	14 310	16 691	11 103		
					(61,704)	(57,717)	(53,998)	(40,974)	(43,142)	(30,777)	(36,137)	(23,838)		
Ground Line					29 583	26 386	25 770	18 542	20 579	13 934	17 019	10 858		
					(69,892)	(56,704)	(55,722)	(39,887)	(44,499)	(29,959)	(36,789)	(23,320)		
-1.5 m (-5 ft.)			18 560	18 560	32 751	26 313	25 587	18 338	20 522	13 749	16 753	10 755		
			(42,711)	(42,711)	(70,992)	(56,510)	(55,356)	(39,429)	(44,342)	(29,561)	(36,067)	(23,121)		
-3.0 m (-10 ft.)	20 695	20 695	30 186	30 186	30 768	26 486	24 398	18 375	19 560	13 767				
	(46,802)	(46,802)	(69,025)	(69,025)	(66,644)	(56,882)	(52,716)	(39,513)	(42,114)	(29,620)				
-4.5 m (-15 ft.)			34 430	34 430	27 474	26 903	21 900	18 657	17 089	14 047				
			(74,510)	(74,510)	(59,278)	(57,812)	(47,044)	(40,158)	(36,205)	(30,306)				
-6.0 m (-20 ft.)			27 445	27 445	22 087	22 087	16 999	16 999						
			(58,692)	(58,692)	(46,986)	(46,986)	(35,451)	(35,451)						

Lift Capacities (continued) 870G LC

Boldface type indicates hydraulically limited capacity; lightface type indicates stability-limited capacities, in kg (lb.). Ratings at bucket lift hook; machine equipped with standard gauge and situated on firm, uniform supporting surface. Total load includes weight of cables, hook, etc. Figures do not exceed 87 percent of hydraulic capacities or 75 percent of weight needed to tip machine. All lift capacities are based on ISO 10567 (with power boost).

Load Point Height	3.0 m (10 ft.)		4.5 m (15 ft.)		6.0 m (20 ft.)		7.5 m (25 ft.)		9.0 m (30 ft.)		10.5 m (35 ft.)		12.0 m (40 ft.)		
Horizontal Distance from Centerline of Rotation	Over Front	Over Side	Over Front	Over Side	Over Front	Over Side	Over Front	Over Side	Over Front	Over Side	Over Front	Over Side	Over Front	Over Side	
<i>With 2.0-m³ (2.63 cu. yd.) bucket, 4.4-m (14 ft. 5 in.) arm, 10.0-m (32 ft. 10 in.) boom, and 900-mm (36 in.) double-bar grouser shoes</i>															
9.0 m (30 ft.)												10 151	10 151	9756	9756
												(22,132)	(22,132)	(21,446)	(21,283)
7.5 m (25 ft.)												10 899	10 899	10 132	9810
												(23,662)	(23,662)	(22,105)	(20,957)
6.0 m (20 ft.)							16 521	16 521	13 630	13 630		11 858	11 858	10 724	9483
							(35,416)	(35,416)	(29,377)	(29,377)		(25,670)	(25,670)	(23,319)	(20,312)
4.5 m (15 ft.)							19 241	19 241	15 295	14 885		12 932	11 545	11 408	9083
							(41,259)	(41,259)	(32,945)	(32,099)		(27,955)	(24,832)	(24,750)	(19,473)
3.0 m (10 ft.)							21 599	18 293	16 856	13 987		13 985	10 947	12 110	8686
							(46,412)	(39,516)	(36,327)	(30,155)		(30,219)	(23,547)	(26,236)	(18,631)
1.5 m (5 ft.)							23 185	17 376	18 103	13 284		14 889	10 443	12 734	8338
							(49,966)	(37,469)	(39,061)	(28,616)		(32,178)	(22,456)	(27,568)	(17,886)
Ground Line							23 959	16 880	18 919	12 809		15 545	10 069	13 194	8070
							(51,762)	(36,337)	(40,872)	(27,567)		(33,604)	(21,642)	(28,545)	(17,314)
-1.5 m (-5 ft.)					13 348	13 348	24 068	16 677	19 267	12 546		15 876	9839	13 200	7905
					(31,421)	(31,421)	(52,075)	(35,861)	(41,656)	(26,983)		(34,317)	(21,143)	(28,378)	(16,969)
-3.0 m (-10 ft.)			11 968	11 968	20 969	20 969	23 609	16 679	19 127	12 468		15 807	9756	13 157	7865
			(27,635)	(27,635)	(48,643)	(48,643)	(51,101)	(35,853)	(41,349)	(26,809)		(34,134)	(20,971)	(28,313)	(16,908)
-4.5 m (-15 ft.)	15 257	15 257	20 145	20 145	27 964	24 512	22 563	16 854	18 433	12 559		15 212	9830	12 437	7999
	(34,672)	(34,672)	(46,108)	(46,108)	(60,593)	(52,631)	(48,786)	(36,239)	(39,781)	(27,018)		(32,732)	(21,158)	(26,419)	(17,278)
-6.0 m (-20 ft.)	23 304	23 304	29 883	29 883	25 525	25 021	20 774	17 210	16 994	12 835		13 757	10 112		
	(52,949)	(52,949)	(68,530)	(68,530)	(55,119)	(53,772)	(44,755)	(37,042)	(36,475)	(27,657)		(29,212)	(21,846)		
-7.5 m (-25 ft.)			26 926	26 926	21 895	21 895	17 842	17 809	14 240	13 388					
			(57,739)	(57,739)	(46,867)	(46,867)	(38,010)	(38,010)	(29,895)	(28,975)					

With 1.9-m³ (2.48 cu. yd.) bucket, 5.4-m (17 ft. 9 in.) arm, 10.0-m (32 ft. 10 in.) boom, and 900-mm (36 in.) double-bar grouser shoes

9.0 m (30 ft.)															8717	8717
															(19,090)	(19,090)
7.5 m (25 ft.)												9858	9858	9221	9221	
												(21,398)	(21,398)	(20,090)	(20,090)	
6.0 m (20 ft.)											12 358	12 358	10 883	10 883	9892	9883
											(26,649)	(26,649)	(23,559)	(23,559)	(21,494)	(21,173)
4.5 m (15 ft.)							17 395	17 395	14 090	14 090		12 034	12 029	10 666	9437	
							(37,340)	(37,340)	(30,365)	(30,365)		(26,017)	(25,866)	(23,130)	(20,232)	
3.0 m (10 ft.)							19 975	19 183	15 787	14 568		13 193	11 355	11 466	8984	
							(42,948)	(41,424)	(34,036)	(31,400)		(28,512)	(24,419)	(24,838)	(19,267)	
1.5 m (5 ft.)							21 992	17 948	17 249	13 708		14 242	10 756	12 211	8568	
							(47,391)	(38,713)	(37,224)	(29,529)		(30,782)	(23,125)	(26,435)	(18,377)	
Ground Line							23 285	17 153	18 341	13 069		15 081	10 278	12 822	8225	
							(22,849)	(36,945)	(40,435)	(28,131)		(39,622)	(22,091)	(32,606)	(17,641)	
-1.5 m (-5 ft.)					13 383	13 383	23 894	16 721	19 000	12 658		15 636	9945	13 228	7979	
					(31,212)	(31,212)	(51,669)	(35,977)	(41,078)	(27,228)		(33,810)	(21,368)	(28,555)	(17,115)	
-3.0 m (-10 ft.)			10 774	10 774	18 566	18 566	23 900	16 561	19 202	12 453		15 846	9761	13 146	7846	
			(24,721)	(24,721)	(42,934)	(42,934)	(51,712)	(35,613)	(41,521)	(26,778)		(34,245)	(20,975)	(28,263)	(16,843)	
-4.5 m (-15 ft.)	12 312	12 312	16 579	16 579	25 346	23 979	23 325	16 614	18 907	12 431		15 628	9730	13 057	7847	
	(27,934)	(27,934)	(37,876)	(37,876)	(58,533)	(51,509)	(50,442)	(35,729)	(40,845)	(26,738)		(33,711)	(20,922)	(28,068)	(16,876)	
-6.0 m (-20 ft.)	18 197	18 197	23 583	23 583	27 626	24 408	22 096	16 860	18 010	12 589		14 823	9866	12 050	8033	
	(41,299)	(41,299)	(53,952)	(53,952)	(59,688)	(52,460)	(47,677)	(36,283)	(38,788)	(27,105)		(31,805)	(21,255)	(25,492)	(17,363)	
-7.5 m (-25 ft.)	25 375	25 375	31 576	31 576	24 810	24 810	19 994	17 319	16 247	12 957		13 000	10 237			
	(57,797)	(57,797)	(67,916)	(67,916)	(53,324)	(53,324)	(42,882)	(37,325)	(34,683)	(27,960)		(27,337)	(22,163)			
-9.0 m (-30 ft.)			25 770	25 770	20 524	20 524	16 466	16 466	12 798	12 798						
			(54,676)	(54,676)	(43,483)	(43,483)	(34,644)	(34,644)	(26,223)	(26,223)						

Buckets

A full line of buckets is offered to meet a wide variety of applications. Digging forces are with power boost. Tooth selection includes the John Deere Fanggs™ Standard, Tiger, Twin Tiger, Abrasion panel, or Flare tooth. Replaceable cutting edges and a variety of teeth are available through John Deere Parts. Optional side cutters add 150 mm (6 in.) to bucket widths. Capacities are SAE heaped ratings.

Type Bucket	Bucket Width		Bucket Capacity		Bucket Weight		Bucket Dig Force (SAE)		Bucket Dig Force (ISO)		Arm Dig Force 4.4 m (14 ft. 5 in.) (SAE)		Arm Dig Force 4.4 m (14 ft. 5 in.) (ISO)		Arm Dig Force 5.4 m (17 ft. 9 in.) (SAE)		Arm Dig Force 5.4 m (17 ft. 9 in.) (ISO)		ME Arm Dig Force 2.95 m (9 ft. 8 in.) (SAE)	
	mm	in.	m³	cu. yd.	kg	lb.	kN	lb.	kN	lb.	kN	lb.	kN	lb.	kN	lb.	kN	lb.	kN	lb.
Heavy Duty High Capacity	914	36	2.09	2.7	2767	6,100	360	80,973	369	82,855	264	59,251	270	60,770	230	51,673	236	52,981	361	81,247
	1067	42	2.55	3.3	2972	6,552	360	80,973	369	82,855	264	59,251	270	60,770	230	51,673	236	52,981	361	81,247
	1219	48	3.02	3.9	3177	7,004	360	80,973	369	82,855	264	59,251	270	60,770	230	51,673	236	52,981	361	81,247
	1370	54	3.49	4.6	3558	7,844	360	80,973	369	82,855	264	59,251	270	60,770	230	51,673	236	52,981	361	81,247
	1524	60	3.98	5.2	3572	7,875	360	80,973	369	82,855	264	59,251	270	60,770	230	51,673	236	52,981	361	81,247
Heavy Capacity Dirt	1829	72	4.96	6.5	3786	8,346	360	80,973	369	82,855	264	59,251	270	60,770	230	51,673	236	52,981	361	81,247
	2032	80	5.63	7.4	4519	9,963	360	80,973	369	82,855	264	59,251	270	60,770	230	51,673	236	52,981	361	81,247
	2286	90	5.81	7.6	4296	9,471	341	76,746	379	85,298	268	60,338	275	61,885	275	61,782	307	69,050	370	83,150
	914	36	1.51	2.0	2510	5,534	372	83,647	414	92,967	276	62,098	283	63,691	300	67,336	335	75,259	384	86,270
	1067	42	1.86	2.4	2761	6,087	372	83,647	414	92,967	276	62,098	283	63,691	300	67,336	335	75,259	384	86,270
Truck Loading	1219	48	2.22	2.9	2935	6,471	372	83,647	414	92,967	276	62,098	283	63,691	300	67,336	335	75,259	384	86,270
	1370	54	2.58	3.4	3091	6,814	372	83,647	414	92,967	276	62,098	283	63,691	300	67,336	335	75,259	384	86,270
	1524	60	2.95	3.9	3232	7,125	372	83,647	414	92,967	276	62,098	283	63,691	300	67,336	335	75,259	384	86,270
	2134	84	4.21	5.5	3285	7,242	363	81,638	404	90,735	274	61,607	281	63,186	238	53,456	244	54,809	380	85,393
	2337	92	4.63	6.0	3598	7,932	363	81,638	404	90,735	274	61,607	281	63,186	238	53,456	244	54,809	380	85,393

Lift Capacities (continued) 870G LC

Boldface type indicates hydraulically limited capacity; lightface type indicates stability-limited capacities, in kg (lb.). Ratings at bucket lift hook; machine equipped with standard gauge and situated on firm, uniform supporting surface. Total load includes weight of cables, hook, etc. Figures do not exceed 87 percent of hydraulic capacities or 75 percent of weight needed to tip machine. All lift capacities are based on ISO 10567 (with power boost).

Load Point Height	3.0 m (10 ft.)		4.5 m (15 ft.)		6.0 m (20 ft.)		7.5 m (25 ft.)		9.0 m (30 ft.)		10.5 m (35 ft.)		12.0 m (40 ft.)	
Horizontal Distance from Centerline of Rotation	Over Front	Over Side	Over Front	Over Side	Over Front	Over Side	Over Front	Over Side	Over Front	Over Side	Over Front	Over Side	Over Front	Over Side
With 2.0-m ³ (2.63 cu. yd.) bucket, 4-4-m (14 ft. 5 in.) arm, 10.0-m (32 ft. 10 in.) boom, and 1020-mm (40 in.) double-bar grouser shoes														
9.0 m (30 ft.)											10 151 (22,131)	10 151 (22,131)	9756 (21,445)	9756 (21,445)
7.5 m (25 ft.)											10 899 (23,662)	10 899 (23,662)	10 132 (22,105)	9922 (21,199)
6.0 m (20 ft.)							16 521 (35,416)	16 521 (35,416)	13 630 (29,377)	13 630 (29,377)	11 858 (25,670)	11 858 (25,670)	10 724 (23,319)	9595 (20,555)
4.5 m (15 ft.)							19 241 (41,259)	19 241 (41,259)	15 295 (32,945)	15 044 (32,443)	12 932 (27,955)	11 676 (25,116)	11 408 (24,750)	9195 (19,715)
3.0 m (10 ft.)							21 599 (46,412)	18 494 (39,951)	16 856 (36,327)	14 146 (30,499)	13 985 (30,219)	11 079 (23,832)	12 110 (26,236)	8798 (18,873)
1.5 m (5 ft.)							23 185 (49,966)	17 577 (37,903)	18 103 (39,061)	13 443 (28,959)	14 889 (32,178)	10 574 (22,740)	12 734 (27,568)	8450 (18,129)
Ground Line							23 959 (51,762)	17 081 (36,772)	18 919 (40,872)	12 968 (27,910)	15 545 (33,604)	10 200 (21,927)	13 194 (28,545)	8182 (17,556)
-1.5 m (-5 ft.)					13 350 (31,425)	13 350 (31,425)	24 068 (52,075)	16 878 (36,296)	19 267 (41,656)	12 705 (27,326)	15 876 (34,317)	9970 (21,427)	13 361 (28,727)	8017 (17,211)
-3.0 m (-10 ft.)			11 969 (27,636)	11 969 (27,636)	20 973 (48,661)	20 973 (48,661)	23 609 (51,101)	16 880 (36,288)	19 127 (41,349)	12 626 (27,152)	15 807 (34,134)	9887 (21,255)	13 242 (28,514)	7977 (17,151)
-4.5 m (-15 ft.)	15 257 (34,673)	15 257 (34,673)	20 145 (46,118)	20 145 (46,118)	27 964 (60,593)	24 787 (53,222)	22 563 (48,786)	17 055 (36,674)	18 433 (39,781)	12 717 (27,362)	15 212 (32,732)	9961 (21,442)	12 437 (26,419)	8111 (17,521)
-6.0 m (-20 ft.)	23 308 (52,949)	23 308 (52,949)	29 885 (68,516)	29 885 (68,516)	25 525 (55,119)	25 296 (54,363)	20 774 (44,755)	17 411 (37,477)	16 994 (36,475)	12 994 (28,000)	13 757 (29,212)	10 243 (22,130)		
-7.5 m (-25 ft.)			26 926 (57,739)	26 926 (57,739)	21 895 (46,867)	21 895 (46,867)	17 842 (38,010)	17 842 (38,010)	14 240 (29,895)	13 547 (29,319)				

Bucket Selection Guide*

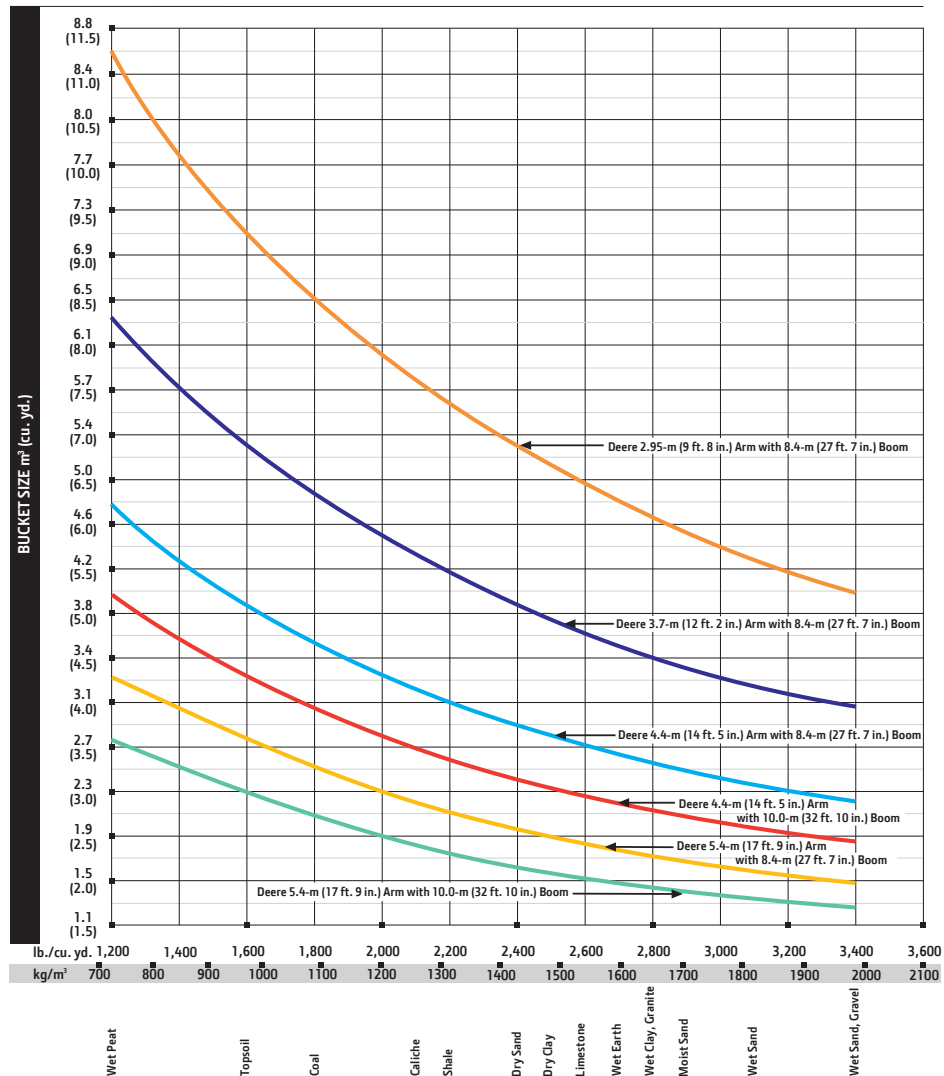

* Contact your John Deere dealer for optimum bucket and attachment selections. These recommendations are for general conditions and average use. Does not include optional equipment such as thumbs or couplers. Larger buckets may be possible when using light materials, for flat and level operations, less compacted materials, and volume loading applications such as mass excavation applications in ideal conditions. Smaller buckets are recommended for adverse conditions such as off-level applications, rocks, and uneven surfaces. Bucket capacity indicated is SAE heaped.

	ME Arm Dig Force 2.95 m (9 ft. 8 in.) (ISO)		Bucket Tip Radius		Number of Teeth
	kN	lb.	mm	in.	
	377	84,686	2426	95.53	3
	377	84,686	2426	95.53	4
	377	84,686	2426	95.53	4
	377	84,686	2426	95.53	5
	377	84,686	2426	95.53	5
	377	84,686	2426	95.53	6
	377	84,686	2426	95.53	6
	386	86,669	2303	90.66	7
	400	89,922	2113	83.19	3
	400	89,922	2113	83.19	4
	400	89,922	2113	83.19	4
	400	89,922	2113	83.19	5
	400	89,922	2113	83.19	5
	396	89,008	2165	85.22	6
	396	89,008	2165	85.22	8

Additional equipment

Key: ● Standard ▲ Optional or special

See your John Deere dealer for further information.

670G	870G	Engine
●	●	Auto-idle system
●	●	Automatic belt-tension device
●	●	Batteries (2 – 12 volt)
●	●	Coolant recovery tank
●	●	Dual-element dry-type air filter
●	●	Electronic engine control
●	●	Enclosed fan guard (conforms to SAE J1308)
●	●	Engine coolant to –37 deg. C (–34 deg. F)
●	●	Fuel filter with water separator
●	●	Full-flow oil filter
●	●	Turbocharger with charge air cooler
●	●	Underhood exhaust after-treatment device with curved outlet
●	●	Muffler, under hood, with vertical curved end exhaust stack
●	●	Cool-on-demand hydraulic-driven fan
●	●	Glow-plug start aid
●	●	500-hour engine-oil-change interval
●	●	70% (35 deg.) off-level capability
●	●	Hydraulic fan reverser
Hydraulic System		
●	●	Reduced-drift valve for boom down, arm in
●	●	Auxiliary hydraulic valve section
●	●	Spring-applied, hydraulically released automatic swing brake
●	●	Auxiliary hydraulic-flow adjustments through monitor
●	●	Auto power lift
●	●	4,000-hour hydraulic-oil-change interval
▲	▲	Auxiliary pilot and electric controls
▲	▲	Hydraulic filter restriction indicator kit
▲	▲	Load-lowering control device
▲	▲	Single-pedal propel control
▲	▲	Pattern changer
Undercarriage		
●	●	Planetary drive with axial piston motors
●	●	Propel motor shields
●	●	Spring-applied, hydraulically released automatic propel brake
●	●	Track guides, front idler and center
●	●	2-speed propel with Autoshift
●	●	Upper carrier rollers (3)
●	●	Sealed and lubricated track chain
▲	▲	Double-bar grouser shoes, 650 mm (26 in.)
▲	▲	Double-bar grouser shoes, 750 mm (30 in.)
▲	▲	Double-bar grouser shoes, 900 mm (36 in.)
▲	▲	Double-bar grouser shoes, 1020 mm (40 in.)

670G	870G	Upperstructure
●	●	Right- and left-hand mirrors
●	●	Vandal locks with ignition key: Cab door / Fuel cap / Service doors / Toolbox
●	●	Debris screen in side panel
●	●	Service platform, left side
●	●	Remote-mounted engine oil and fuel filters
▲	▲	Counterweight-removal system
Front Attachments		
●	●	Centralized lubrication system
●	●	Dirt seals on all bucket pins
●	●	Lubricator with hose reel and grease gun
●	●	No-boom-arm option
▲	▲	Boom, 7.8 m (25 ft. 7 in.)
▲	▲	Boom, 8.4 m (27 ft. 7 in.)
▲	▲	Boom, mass excavating, 6.8 m (22 ft. 4 in.)
▲	▲	Boom, mass excavating, 7.1 m (23 ft. 4 in.)
▲	▲	Boom, reach, 10.0 m (32 ft. 10 in.)
▲	▲	Arm, mass excavating, 2.9 m (9 ft. 6 in.)
▲	▲	Arm, mass excavating, 2.95 m (9 ft. 8 in.)
▲	▲	Arm, 3.6 m (11 ft. 10 in.)
▲	▲	Arm, 3.7 m (12 ft. 2 in.)
▲	▲	Arm, 4.2 m (13 ft. 9 in.)
▲	▲	Arm, 4.4 m (14 ft. 5 in.)
▲	▲	Arm, 5.3 m (17 ft. 5 in.)
▲	▲	Arm, 5.4 m (17 ft. 9 in.)
▲	▲	Boom cylinder with plumbing to mainframe for no-boom-arm option
▲	▲	Buckets: Heavy duty / Heavy-duty high capacity / Side cutters and teeth
Operator's Station		
●	●	Adjustable independent-control positions (levers-to-seat, seat-to-pedals)
●	●	AM/FM radio
●	●	Auto climate control/air conditioner/heater/pressurizer, 5.9 kW (20,000 Btu/hr.)
●	●	Built-in Operator's Manual storage compartment and manual
●	●	Cell-phone power outlet, 12 volt, 60 watt, 5 amp
●	●	Coat hook
●	●	Deluxe air-suspension heated cloth seat with 100-mm (4 in.) adjustable armrests
●	●	Floor mat
●	●	Front windshield wiper with intermittent speeds
●	●	Gauges (illuminated): Engine coolant / Fuel
●	●	Horn, electric
●	●	Hourmeter, electric
●	●	Hydraulic shutoff lever, all controls

670G	870G	Operator's Station (continued)
●	●	Hydraulic warm-up control
●	●	Interior light
●	●	Large cup holder
●	●	Machine Information Center (MIC)
●	●	Mode selectors (illuminated): Power modes – 3 / Travel modes – 2 / Work mode – one for the 670G LC and 2 for the 870G LC / Boom mode
●	●	Multifunction, color LCD monitor with: Diagnostic capability / Multiple-language capabilities / Maintenance tracking / Clock / System monitoring with alarm features: Auto-idle indicator, engine air cleaner restriction indicator light, engine check, engine coolant temperature indicator light with audible alarm, engine oil pressure indicator light with audible alarm, low-alternator-charge indicator light, low-fuel indicator light, fault code alert indicator, fuel-rate display, wiper-mode indicator, work-lights-on indicator, and work-mode indicator
●	●	Fluid-level switch and indicator light for engine coolant and engine oil
●	●	Motion alarm with cancel switch (conforms to SAE J994)
●	●	Power-boost switch on right console lever
●	●	Propel pedals and levers
●	●	SAE 2-lever control pattern
●	●	Seat belt, 51 mm (2 in.), retractable
●	●	Tinted glass
●	●	Transparent tinted overhead hatch
●	●	Hot/cold beverage compartment
▲	▲	24- to 12-volt D.C. radio converters, 10 amp
▲	▲	Monitor system with alarm features: Hydraulic oil filter restriction indicator light
▲	▲	Protection screens for cab front, rear, and side
▲	▲	Seat belt, 76 mm (3 in.), non-retractable
▲	▲	Window vandal-protection covers
Electrical		
●	●	50-amp alternator
●	●	Blade-type multi-fused circuits
●	●	Positive-terminal battery covers
●	●	JDLINK™ wireless communication system
●	●	Rearview camera
▲	▲	Cab extension wiring harness
Lights		
●	●	Work lights: Halogen / 2 mounted on boom / One mounted on frame / 2 mounted on top of cab



Net engine power is with standard equipment including air cleaner, exhaust system, alternator, and cooling fan, at test conditions specified per ISO 9249. No derating is required up to 2000-m (6,560 ft.) altitude. Specifications and design subject to change without notice. Wherever applicable, specifications are in accordance with SAE standards. Except where otherwise noted, these specifications are based on units with 1370-mm (54 in.) buckets, 900-mm (36 in.) double-bar grouser shoes, full fuel tanks, and 79-kg (175 lb.) operators; a 670G LC unit with 10 400-kg (22,928 lb.) counterweight; and a 870G LC unit with 13 300-kg (29,321 lb.) counterweight.

www.JohnDeere.com